

OIL-FREE HIGH-SPEED DRIVE CENTRIFUGAL COMPRESSOR

ZH 350+ (350 kW / 470 hp)



Atlas Copco





SUPERB ENERGY EFFICIENCY AND RELIABILITY

Atlas Copco's ZH 350+ oil-free centrifugal compressor is designed to save energy. The unique combination of optimal 3-stage compression, titanium impellers, the high-speed, high-efficiency motor, magnetic bearings and low pressure drops reduce energy consumption to previously unattainable low levels.

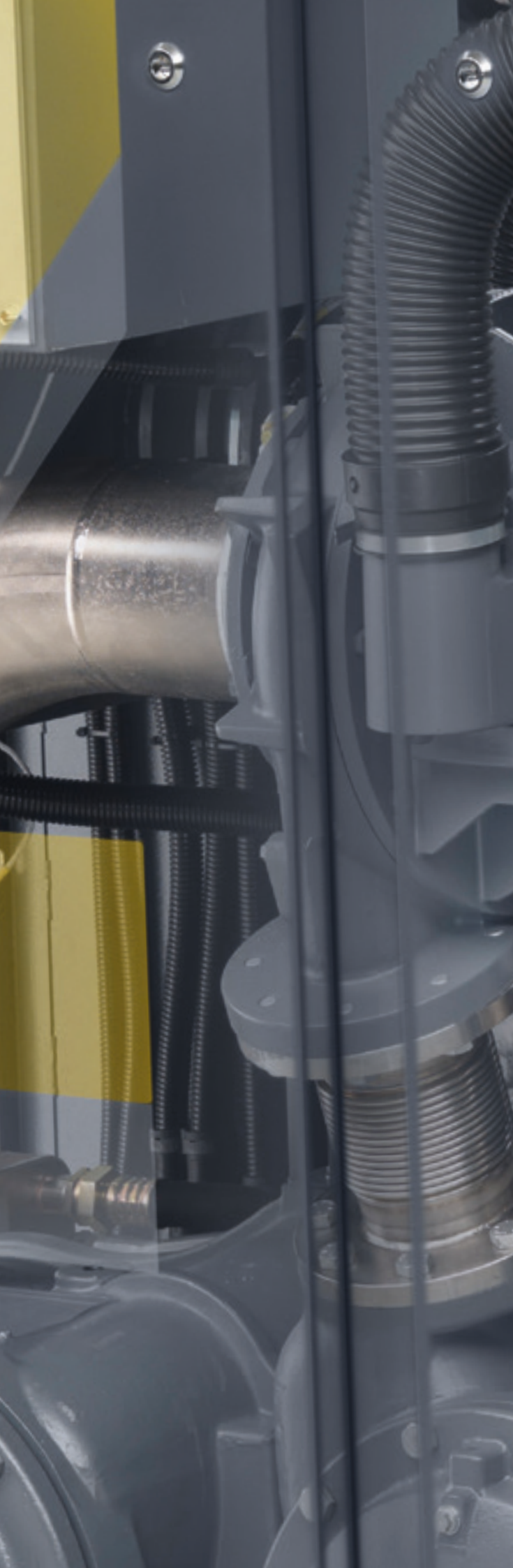

Driving down energy costs

Atlas Copco is committed to offer superb energy-efficient technologies. All components of the ZH 350+ are designed to save energy. The high-speed drive means no oil lubrication, no intermediate gears and fewer rotating components, all of which combine to reduce friction and drive down energy costs. The backward leaning impeller and the carbon ring air seals are designed to increase the operating range and provide the highest air volume with the lowest energy requirement.

Keeping your production up and running

All ZH 350+ components are easy to maintain, dismantle and re-assemble if required, increasing uptime. Advanced control and monitoring ensures that production interruptions are minimized. In addition, easily accessible components, minimal service interventions and long overhaul intervals reduce maintenance time and costs.

Easy installation

The integrated design of the ZH 350+ includes air intake filter, coolers, internal cooling system, motor, and control system: all supplied as a ready-to-use package. Installation is fault-free, commissioning time is low and no external instrument air is required. You simply plug and run.

Protecting your reputation and production

ZH 350+ compressors provide you with 100% pure, clean air that complies with ISO 8573-1 CLASS 0 (2010) certification. This means zero risk of contamination; damaged or unsafe products; operational downtime; and damaging your company's hard-won professional reputation. Atlas Copco was the first manufacturer in the world to receive such accreditation on an oil-free compressor.

Global presence - local service

Our aftermarket product portfolio is designed to add maximum value for our customers by ensuring the optimum availability and reliability of their compressed air equipment with the lowest possible operating costs. We deliver this complete service guarantee through our extensive service organization, maintaining our position as leader in compressed air.

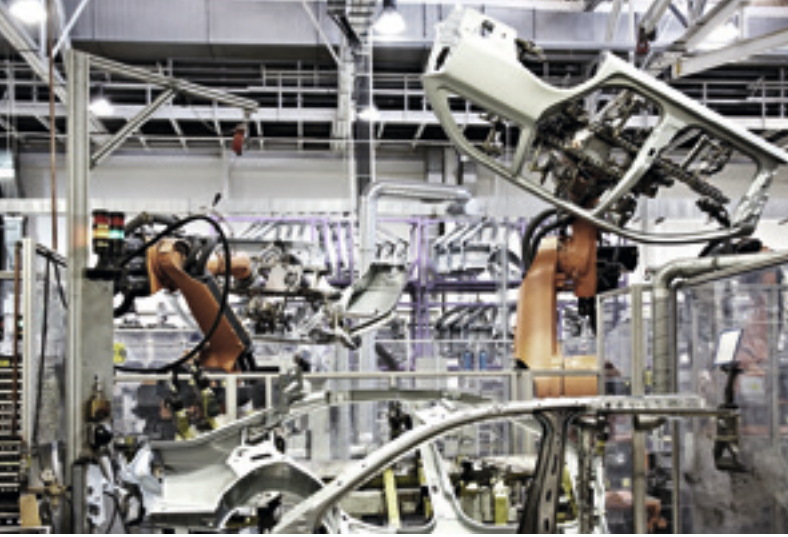

MEETING YOUR PRECISE NEEDS

This innovative compressor provides reliable operation in the most demanding environments. For optimum product quality, air is 100% certified oil-free according to ISO 8573-1 CLASS 0 (2010).

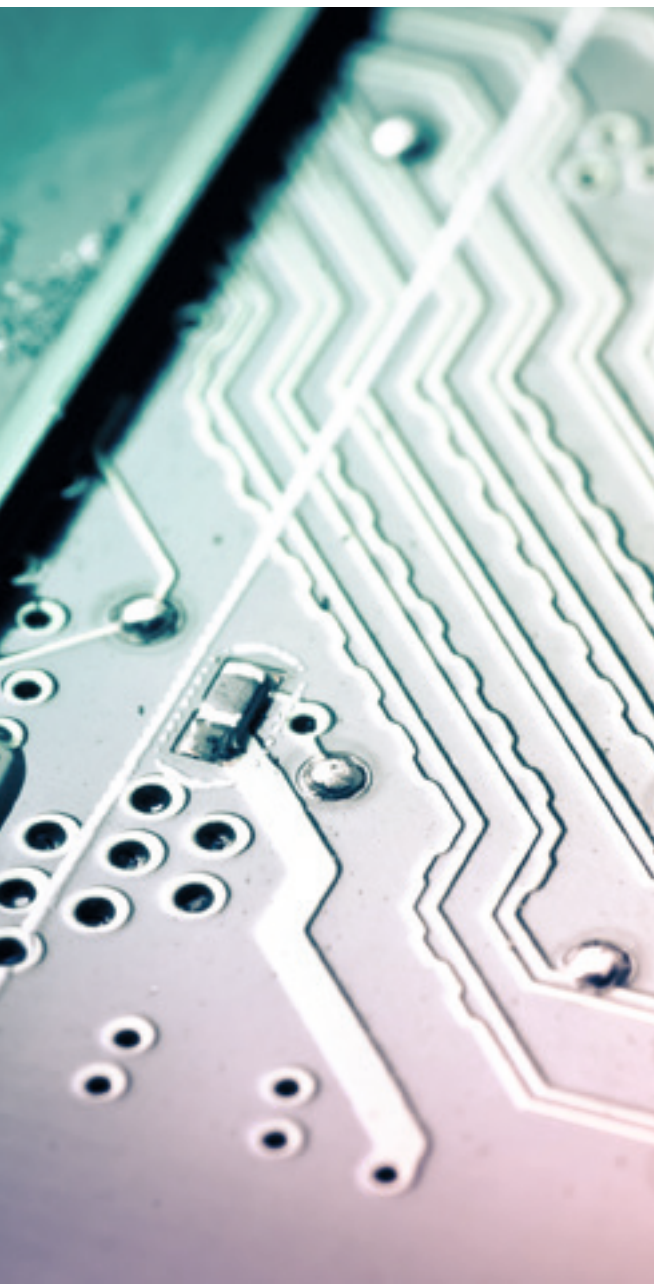

Manufacturing

The demands placed on equipment in the manufacturing industry are very high. A dependable stream of 100% certified oil-free compressed air is crucial to keep the production up and running at all times. Atlas Copco's ZH 350+ compressor solutions operate dependably in extreme temperature and humidity conditions where high-performance levels and reliability are essential.

Electronics

ZH 350+ compressors are ideally suited for electronics applications where moisture can affect sensitive processes and cause oxidation of micro-terminal strips, resulting in product failure. Similarly, microelectronics manufacturers depend on clean, dry air to remove microscopic debris from the surfaces of computer chips and computer boards. In such applications, the high reliability of ZH 350+ compressors is essential.

Pharmaceuticals

Pharmaceutical companies have a tight control on energy consumption and costs, which is why they frequently turn to the highly cost-efficient ZH 350+ air compressor from Atlas Copco. Pharmaceutical manufacturing plants also require clean air. Atlas Copco's ZH 350+ oil-free air compressor is certified according to ISO 8573-1 CLASS 0 (2010), which stands for zero risk of contamination, zero risk of damaged or unsafe products, and zero risk from operational downtime.

Automotive

To maximize productivity in the automotive industry, downtime has to be eliminated. Atlas Copco's reliable ZH 350+ air compressor stands for an integrated package that is designed for long-lasting performance. What's more, they are easy to install, operate and service.

CLASS 0: THE INDUSTRY STANDARD

Oil-free air is used in all kinds of industries where air quality is paramount for the end product and production process. These applications include food and beverage processing, pharmaceutical manufacturing and packaging, chemical and petrochemical processing, semiconductor and electronics manufacturing, the medical sector, automotive paint spraying, textile manufacturing and many more. In these critical environments, contamination by even the smallest quantities of oil can result in costly production downtime and product spoilage.

First in oil-free air technology

Over the past sixty years Atlas Copco has pioneered the development of oil-free air technology, resulting in a range of air compressors and blowers that provide 100% pure, clean air. Through continuous research and development, Atlas Copco achieved a new milestone, setting the standard for air purity as the first manufacturer to be awarded CLASS 0 certification.

Eliminating any risk

As the industry leader committed to meeting the needs of the most demanding customers, Atlas Copco requested the renowned TÜV institute to type-test its range of oil-free compressors and blowers. Using the most rigorous testing methodologies available, all possible oil forms were measured across a range of temperatures and pressures. The TÜV found no traces of oil at all in the output air stream.

CLASS	Concentration total oil (aerosol, liquid, vapor) mg/m ³
0	As specified by the equipment user or supplier and more stringent than class 1
1	< 0.01
2	< 0.1
3	< 1
4	< 5

Current ISO 8573-1 (2010) classes (the five main classes and the associated maximum concentration in total oil content).



THE TOP ENERGY-SAVER

1

Three-stage compression

- More air flow per unit of power and broader operating range.
- High thermodynamic efficiency.



2

High-strength titanium impellers

- Permit frequent and fast load/unload transitions.
- Optimum strength to weight ratio leads to higher efficiency, rotor stability and reliability.

3

Two high-speed synchronous motors

- Frictionless magnetic bearings.
- Water-cooled jackets for effective heat dissipation.
- No gearbox, no oil lubrication required.

4

Control & monitoring

- To keep a firm grip on costs, the advanced control system allows you to monitor overall system performance with service indications, malfunction alarms and safety shutdowns. The multi-language text display is easy to use.
- Optional ES multi-compressor controller possibilities.



6

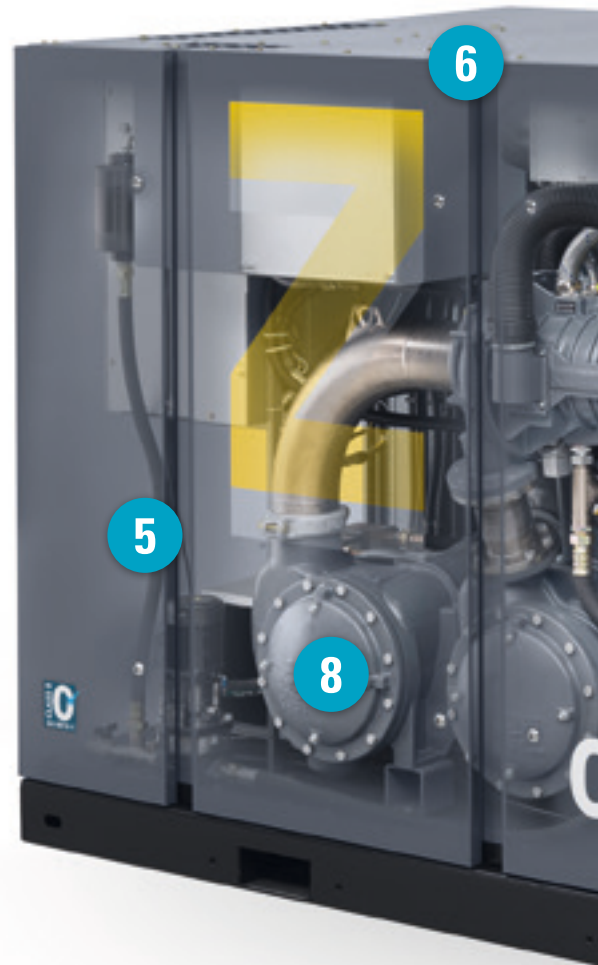

5

8



8

High-efficiency coolers with stainless steel tube bundles

- Pre-installed before aftercooler within the package.
- No air expansion losses during unload operation.
- Reduced installation and space costs.

4

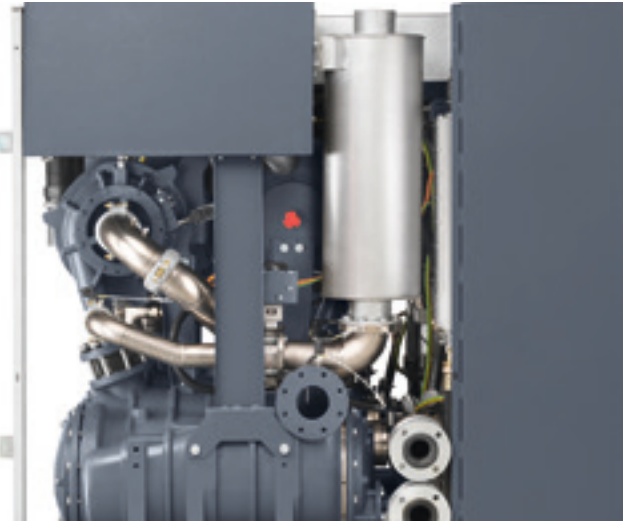

7

Integrated blow-off valve with silencer

- Pre-installed before aftercooler within the package.
- No air expansion losses during unload operation.
- Reduced installation and space costs.

6

Pre-mounted air intake filter with silencer

- Designed for very low pressure drop.
- Large surface area to cope with harsh environments.

5

Closed loop water system with thermostatic valve

- Extended life time of electronic power components.
- Constant internal cooling water temperature.
- Independent of external cooling water quality.

WORKING PRINCIPLE

The air enters the ZH 350+ via the air filter (1) and then proceeds through three stages of compression (2). After each stage, an inter- or aftercooler (3) cools down the hot air. After the third stage of compression blow-off (4) takes place before the check valve (5) and aftercooler to rapidly de-pressurize the compressor's internal air volume during unload transitions.

The three stages of compression are driven by two high-speed motors (6) without a gearbox. The motors and frequency inverters (7) are cooled in two parallel streams by an internal closed water cooling system, which features a thermostatic valve (9) to maintain a constant water temperature and a water pump (10) for water circulation.

The internal closed loop cooling system is independent of the cooling water quality supplied externally. The cooling water is also distributed among the internal heat exchanger (8). Optional components include Atlas Copco's ND heat-of-compression rotary drum dryer (11), and pre-heating of part of the hot air (12) after the third stage if required.

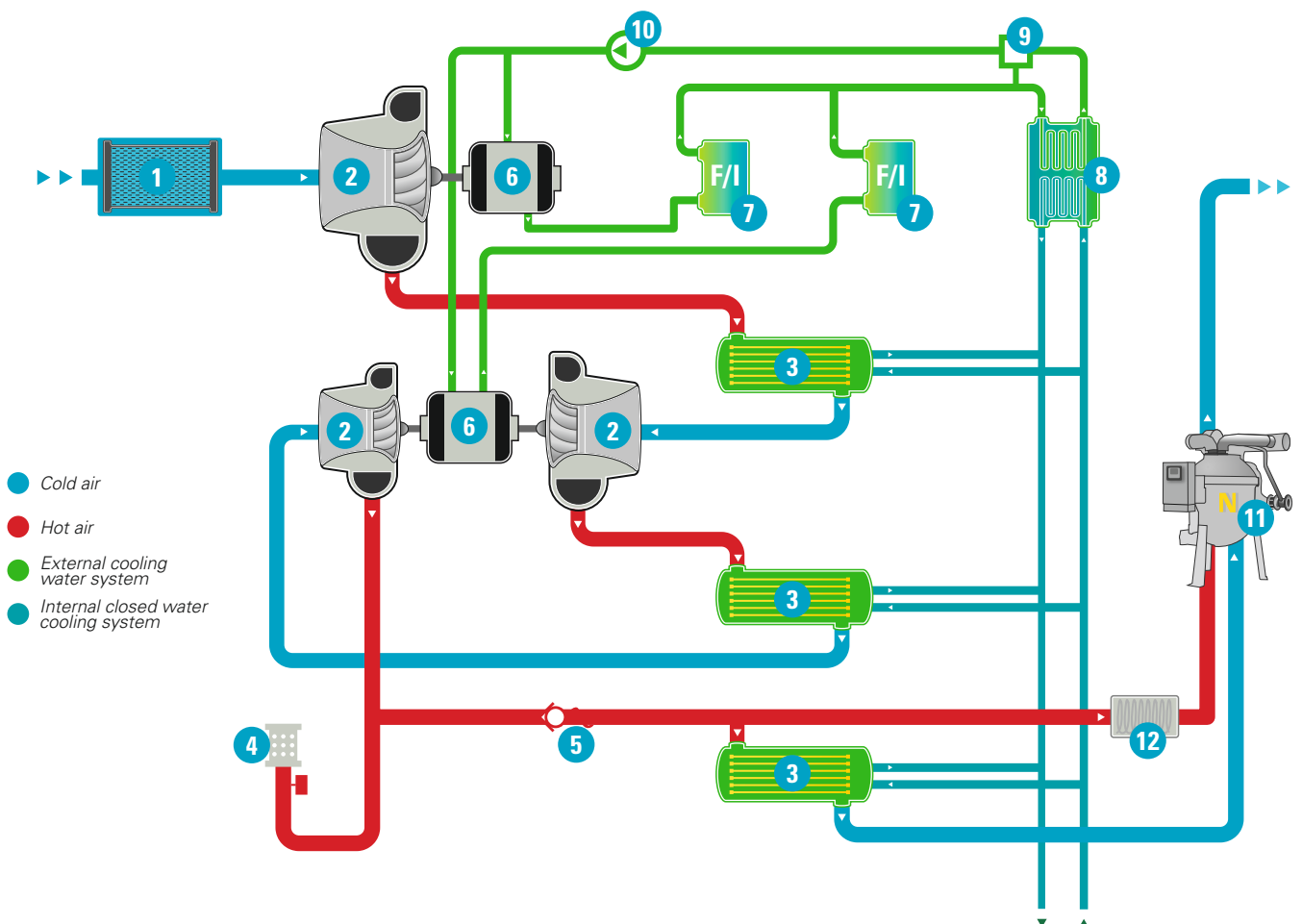

OPTIMIZE YOUR COMPRESSOR ROOM

Thorough assessment of air flow demand profiles in the industry reveal that they can be either stable with limited fluctuations, highly fluctuating and hence less predictable or a combination of both. In all these cases Atlas Copco can offer you the most efficient solution based on a combination of different compression technologies.

Stable demand

Flow



Time

Highly fluctuating demand

Flow

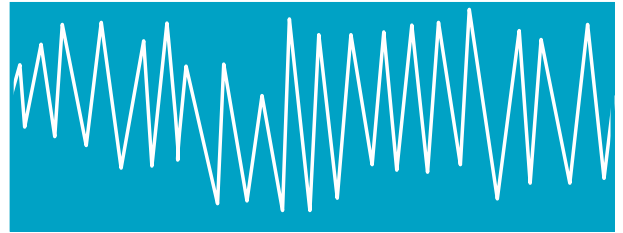

Time

The ZH 350+ handles air demand fluctuations more effectively than turbo technology could do up to now. Its fast transitions between load and unload operation eliminate the need for expensive blow-down of compressed air in times of low air demand.

Fluctuating demand + stable base load

Flow



Time

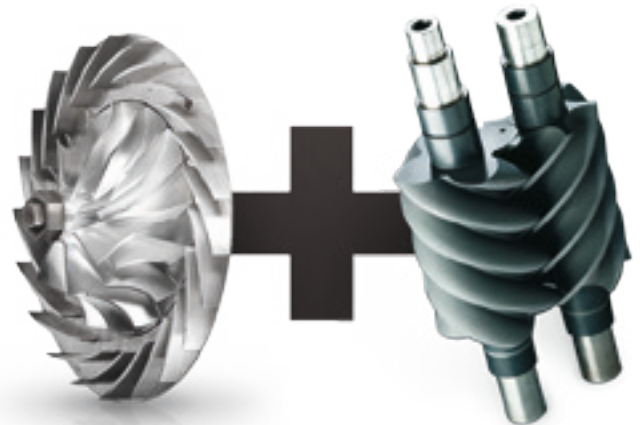

The combination of turbo and screw brings the energy bill further down in larger compressor rooms. While the Variable Speed Drive (VSD) screw accommodates the large fluctuations, the turbo efficiently takes care of the base flow requirements.

Contract Air

With Contract Air, Atlas Copco provides customers with compressed air or gas at specified pressure, dew point, purity, etc. It includes compressed air equipment, ancillaries, installation, full maintenance, repairs, spare parts and annual audits.

Major benefits:

- No investments needed.
- Compressed air cost matches consumption: only pay for the air you consume.
- Zero worries: uptime of equipment, air quality and energy efficiency are contractually guaranteed.
- Transparent costs: no breakdown costs, no stock of spare parts.
- Flexibility: choose your own payment options, contract duration and possible buy-ins.

For more information on Contract Air, please contact your local Atlas Copco representative.



SUPERIOR ENERGY EFFICIENCY

The ZH 350+ is Atlas Copco's most energy-efficient compressor, offering outstanding energy savings compared to conventional compressors.

Three-stage compression

The three-stage design of the ZH 350+ uses the best-performing technology currently available to achieve high thermodynamic efficiency and lower power consumption. A three-stage design is widely recognized as the most efficient design for achieving compression between 6 to 11 bar(e) / 90 to 160 psig with a turbo compressor, resulting in 4 to 9% more air flow per unit of power and a broader operating range. Coated stages and stainless steel diffusers provide excellent performance stability over time.

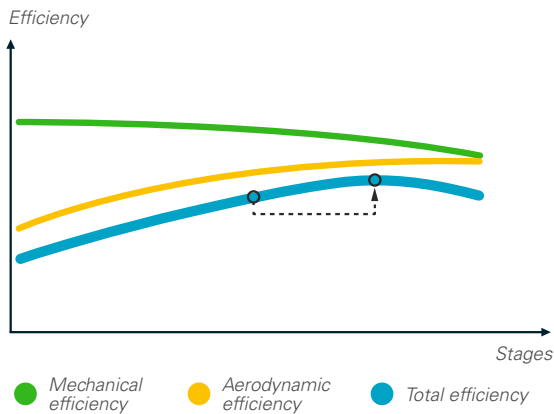

No gears, no oil, minimal friction

The ZH 350+ completely eliminates the gearbox and therefore also the transmission losses normally associated with a gearbox, improving energy efficiency by up to 9%. No oil changes further limit operational costs. In addition, the compressor size is drastically reduced.

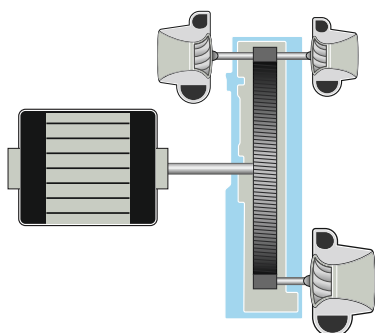

With gearbox

- High transmission losses
- Large footprint
- Lubrication required

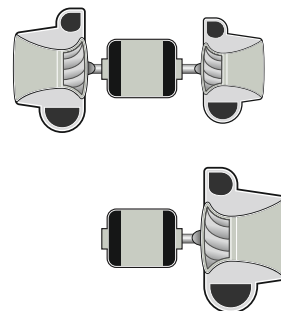

Without gearbox (ZH 350+)

- Low transmission losses
- Compact design
- No lubrication, low maintenance

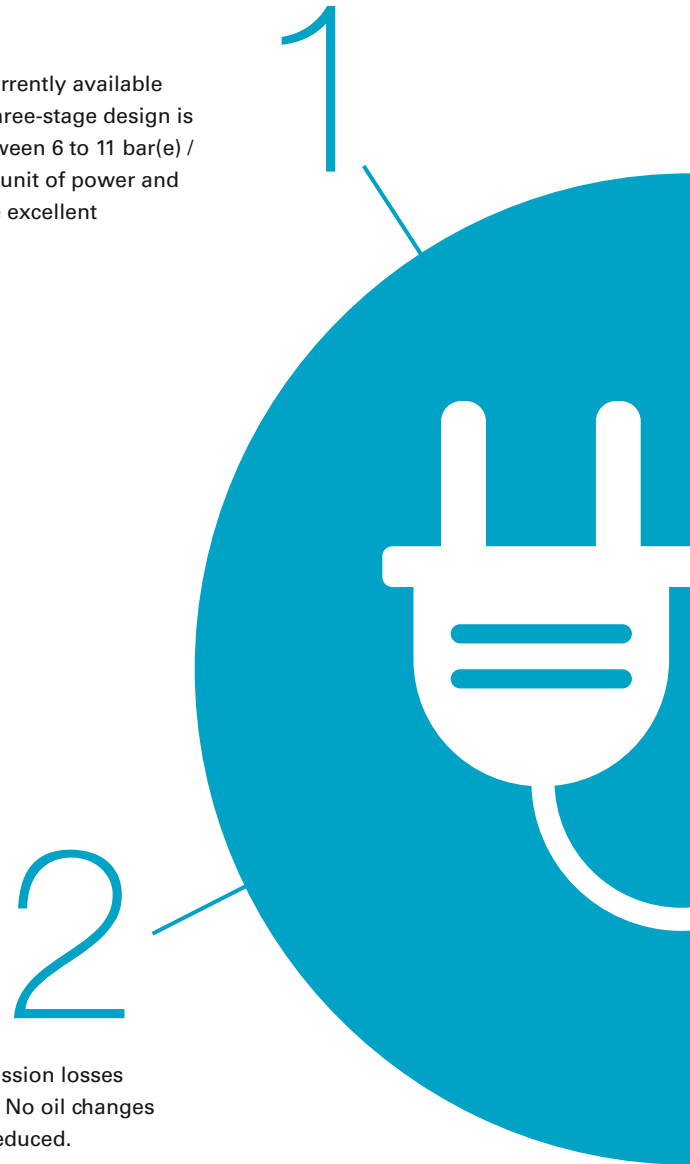

Stable internal cooling temperatures

Stable internal cooling water temperatures extend the lifetime of electronic power components such as the frequency inverter and motor and increase drive efficiency for stable performance control.

Optimally sized coolers

The design features an enhanced heat transfer area which has a positive impact on the operation and stability of the consequent compression stages. Minimum energy consumption during load/unload transitions is achieved by blow-off after the third stage before the aftercooler. It de-pressurizes the compressor's internal air volume only between the compression stages, thereby ensuring minimal loss of compressed air.

Efficient drive

The ZH 350+ is directly driven by a permanent magnetic synchronous motor, which is vastly superior to conventional types. It reduces energy losses and cooling requirements and offers a higher speed in a more compact design. A consistently high motor efficiency with low rotor losses is maintained across the entire speed range both at full load and partial load. Whereas conventional motors need power to excite a magnetic field in the rotor, this is unnecessary in the ZH 350+ thanks to the permanent magnets in the rotor.

Titanium impellers for increased lifetime and lower power consumption

The ZH 350+ titanium impellers have superior fatigue properties and hence permit faster load-unload cycles. Reduced transition time between load-unload results in lower power consumption. The path of minimal energy consumption is followed. Further operating efficiency is achieved by speed regulation in the turndown zone.

Pressure

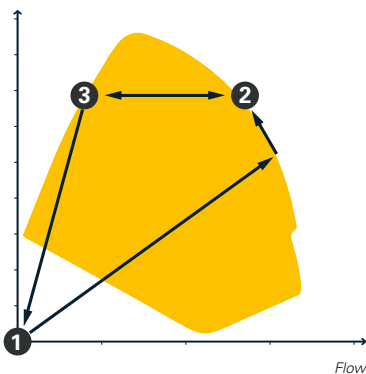

Two optimal working points

- 1 Unload: 1.5%
- 2 Full load: 100%
- 2 3 Efficient operation:
by speed regulation in turndown zone
- 1 2 Fast acceleration:
path of least power consumption
- 3 1 Fast deceleration:
path of least power consumption



MONITORING AND CONTROL: HOW TO GET THE MOST FROM THE LEAST

To help customers increase efficiency and reliability, Atlas Copco equips its compressed air products with advanced control and monitoring systems. Easily expandable with extra sensors, digital contacts, fieldbus, Internet and SMS communication functions, the controller can be adapted to specific customer needs.



Operating modes:

- Auto-dual control (0-100% blow-off)
- Constant Pressure Control (partial blow-off)

Functions:

- Flow control (IGV regulation)
- Blow-off regulation
- Surge anticipation
- Turndown optimization
- Preventive maintenance warning
- Safety control

ES fully optimized system

A properly managed compressed air network will save energy, reduce maintenance, decrease downtime, increase production and improve product quality. Atlas Copco's ES central controllers are the most efficient way to monitor and control multiple compressors and blowers simultaneously as well as dryers and filters. An ES controller offers one central point of control for your whole compressed air network, ensuring all compressors and blowers provide optimum performance for your process. The result is a completely dependable and energy efficient network, giving you peace of mind and keeping your costs to a minimum.



SMARTLINK*: Data Monitoring Program

- A remote monitoring system that helps you optimize your compressed air system and save you energy and cost.
- It offers you a complete insight in your compressed air network and anticipates on potential problems by warning you up-front.

**Please contact your local sales representative for more information*

A DRYER SOLUTION FOR EVERY NEED

Untreated compressed air contains moisture and possibly dirt particles that can damage your air system and contaminate your end product. The resulting maintenance costs far exceed air treatment costs. Atlas Copco believes in effective prevention and provides a complete range of air treatment solutions to protect investments, equipment, production processes and end products.

Heat of compression reactivated adsorption dryers

XD-G/XD⁺-G

-70°C/-40°C/-20°C

-94°F/-40°F/-4°F

XD-S

-20°C/+3°C

-4°F/+37°F

- Use of freely available heat of compression.
- Limited pressure drop.
- Variants for dew point suppression and guaranteed dew point.
- Variants without loss of compressed air.

Rotary drum heat of compression dryers

ND

-40°C/-20°C

-40°F/-4°F

MD

-20°C/+3°C

-4°F/+37°F

- Use of freely available heat of compression.
- Negligible power consumption.
- Variants with extra heat augmentation for lower dew points.



Heat reactivated adsorption dryer

BD/BD⁺

-70°C / -40°C / -20°C

-94°F / -40°F / -4°F

- Use of electrical heaters for regenerating the desiccant.
- Limited pressure drop.
- Variants without loss of compressed air.

Refrigerant dryer

FD

+3°C / +20°C

+37°F / +68°F

- Use of cooling circuit for cooling down compressed air.
- Guaranteed pressure dew points.
- Lowest energy consumption in all operating conditions.
- Air and water cooled variants.

SCOPE OF SUPPLY

Air circuit	Air intake filter and silencer
	Impellers per stage
	Discharge check valve
	Integrated blow-off valve with silencer
	Compensator on air outlet (DIN / ANSI)
Cooling circuit	Stainless steel inter- and aftercooler cores
	Integrated water-to-water cooler with stainless steel plates
	Thermostatic valve
	Single point inlet and outlet cooling water connection
	Compensators on cooling water inlet and outlet
Electrical components	High-speed Permanent Magnet Synchronous Motor
	Pre-mounted control cubicle with control power transformer
	Advanced electronic control and monitoring system
	Frequency converters
Additional features	Integral baseframe for compressor and drive
	Full acoustical sound attenuating enclosure
	Completely oil-less design
	Magnetic bearings for motor shaft
	Motor winding protection
	EMC tested and certified unit
	Energy-efficient no-loss electronic drains



TECHNICAL SPECIFICATIONS

ZH 350+

Type	Working pressure		Free air delivery ⁽¹⁾						Installed motor power	
	bar(e)	psig	l/s		cfm		m ³ /h		kW	hp
			Min.	Max.	Min.	Max.	Min.	Max.		
50/60 Hz										
ZH 350+	6-9	87-130	700	1100	1483	2330	2520	3960	350	470

(1) Free air delivery and power according to Acceptance Test Code for Electrically Driven Packaged Centrifugal Air Compressors. CAGI bulletin 006-11, January 2011 or Pneurop publication PN2-01, November 2010.

OPTIONS

- Hook up with central controller for multiple compressor installations
- Compatible with heat-of-compression rotary drum dryer, heat recovery

ZH 350+

Width 2400 mm, 94.49"
 Depth 2000 mm, 78.74"
 Height 2017 mm, 79.42"

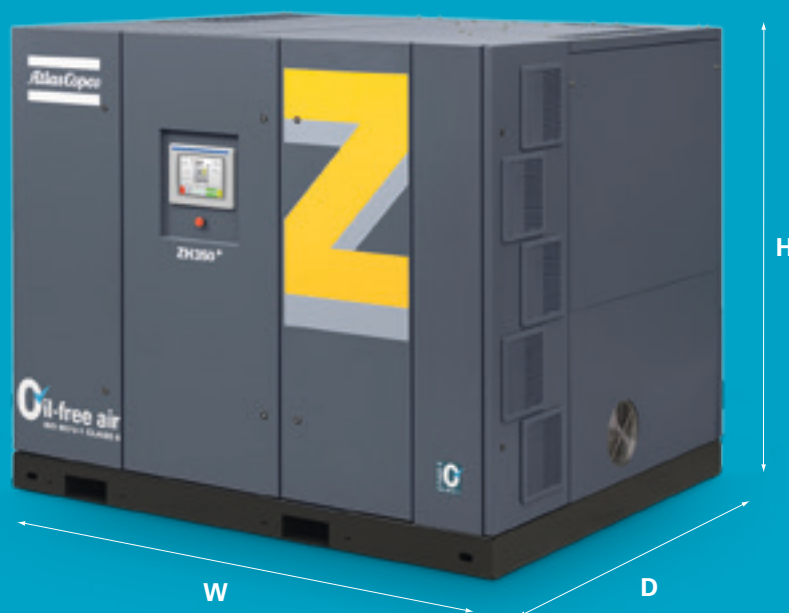

COMMITTED TO SUSTAINABLE PRODUCTIVITY

We stand by our responsibilities towards our customers, towards the environment and the people around us. We make performance stand the test of time. This is what we call – Sustainable Productivity.



www.atlascopco.com

The Atlas Copco logo, featuring the brand name in a stylized, italicized font, is centered between two horizontal teal bars.