



Atlas Copco

Atlas Copco Rental

Atlas Copco Rental  
www.atlascopcorental.com

Atlas Copco Rental  
www.atlascopcorental.com

ENERGY STORAGE MODULE 250-500+

POWER MODULE

Atlas Copco



# Modular power solutions



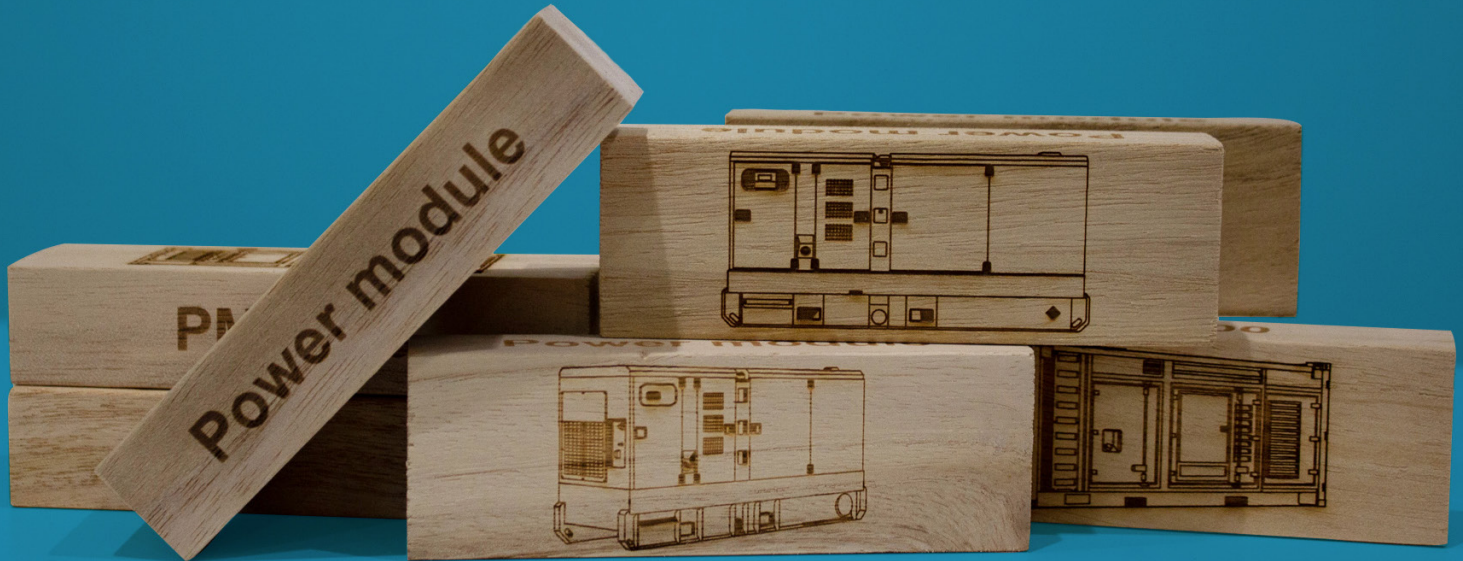

Power module

PM

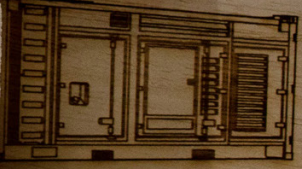
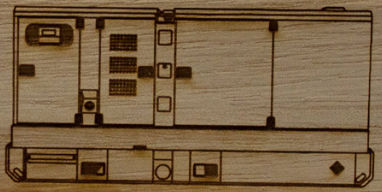
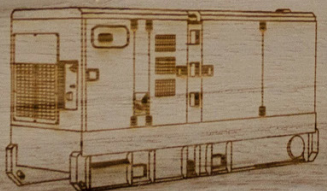

# The right people for the job

While our fleet is, if we say so ourselves, highly recognizable, we do want to put the women and men behind the scenes in the spotlight. From all the way back in the 19th century, when the foundations of Atlas Copco were laid, to today: it's people who make the difference. Skilled sales engineers and logistical support to highly qualified, trained and certified technicians.

**Everyone at Atlas Copco Rental, no matter the department, is dedicated to making our collaboration as smooth as possible, and ... memorable.**

Contact us now:

[www.atlascopcorental.com](http://www.atlascopcorental.com)



# The industry leader

We know you are not looking for specific equipment, but a resource that performs according to specific parameters. For short or long term demands, planned contingencies or emergencies, Atlas Copco Rental is available 24/7 to assist you and provide the most cost- and energy-efficient solutions that meet (and exceed) your expectations. Our fleet consists of state-of-the-art material that allows us to design solutions that will meet your specific needs. Quality of service, environmental care and the highest possible personnel safety are guaranteed. An industry first. **It's our business to keep your business running.**

Atlas Copco Rental division is triple ISO certified:  
ISO 9001 - ISO 14001 - OHSAS 10881



# What do we do

With Atlas Copco Rental, you never get “just the machines”. We pride ourselves in providing exceptional service, which means you get exactly what you want when you need it. Our team manages the entire process from start to finish. No matter its size.

EMERGENCIES 24/7

AGILE ASSET MANAGEMENT

PLANNED PROJECTS

SPECIALTY PROJECTS

“Because peace of mind, costs, and efficiency all matter.”



# Modular power solutions

- From single units to multi-megawatt solutions
- Hybrid and energy storage
- Compact
- Short- or long-term
- Fuel efficiency
- Silent operation
- Plug and play
- Accessories like transforms, switchgear, ...



# Modular solutions made to go anywhere

**From single units to large-scale multi-MW setups, we have the right power solutions for you. Whether you have an emergency or require additional power for a certain period, a temporary power solution from Atlas Copco Specialty Rental gives you the energy you need.**

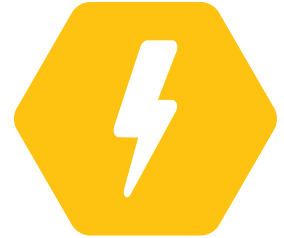

Our Power Modules are built for multi-drop use and designed to move regularly. This means they can be picked up and repositioned, whether that be a few meters or hundreds of miles. Once a month or multiple times a week. It can be done safely without potentially damaging vital components. The corrosion-treated, water-proof canopy and the ability to work at high and low ambient temperatures add an additional layer of protection when running at sea.

The fleet isn't only flexible when it comes to physically moving the units, but performance as well. Specific applications require a minimal power supply to ensure backup and safety systems remain operational and at full power when the application has to start running. Paralleling the generators provides the maximum output when demand peaks and minimum output when demand decreases.

By combining modular power solutions with the Energy Storage Units, Atlas Copco Rental now offers a truly hybrid solution that gives you the best of both worlds. Firstly, an independent power supply, where and when you need it. And secondly, the lowest ecological footprint for a temporary power supply. In short: the greenest possible temporary power solution on the market. Made for rough conditions and exceptional circumstances.



# Stage V modular power generator

## EXCELLENT PERFORMANCE

- High-capacity fuel tank
- Dual stage air-filtration system
- Optional FleetLink intelligent telematics system
- Powered up within seconds
- Innovative Power Management System (PMS)



## ENVIRONMENTALLY FRIENDLY

- HVO compatible
- Fully EU Stage V compliant
- Low noise levels
- Improved carbon footprint
- Enhanced fuel economy

## PLUG AND PLAY

- Extensive safety features
- External connections input and output
- Can be paralleled with other units to form a mobile or independent power plant

## USER FRIENDLY

- Compact size
- Quiet operation
- User-friendly touch-screen controllers



# Energy storage system: power when and where you need it

The ZBC 250-575 Battery Pack allows us to deliver hybrid total solutions. The energy storage system can be used with our diesel-driven Power Modules to enable smart load management. When paralleled with Atlas Copco Specialty Rental power modules, off-grid applications can now achieve significant CO<sub>2</sub> reduction. From urban construction sites to offshore applications. Ready to make an impact but no stable power source available? Let's go hybrid!

## EXCELLENT PERFORMANCE

- Paralleling capability - scalable solution
- Micro grid possibility with genset
- Photovoltaic management
- Temperature control
- Lithium-ion benefits



## ENVIRONMENTALLY FRIENDLY

- Reduce noise pollution, less than 80 dB(A) at 0,5m
- Zero CO<sub>2</sub> and NO<sub>x</sub> emissions
- Provide clean and efficient renewable solutions



## PLUG AND PLAY

- Extensive safety features
- External connections input and output
- User-friendly controls



## EFFICIENT COST OF USERSHIP

- Reduce fuel consumption
- Low service and maintenance interval
- Future proof and low emission zone compatible

# The hybridization of temporary power

The arrival of battery technology and the new Energy Storage Module, now provides the opportunity of hybrid power stations. A power plant is always tailored to your needs; such as the power you require, fluctuations in power demand, local fuel supply, available footprint and potential logistical challenges, access to the site ... and all legal regulations applicable for your working site – such as emissions and safety. Whereas the maximum power level required, typically lead to an oversized diesel power module in the past; in recent years modular power stations optimized your power load more efficiently.



## What is a hybrid power plant?

A hybrid power plant typically combines two different power sources. Its strength is how the sources are optimized, so combined they form a more efficient source of power. A temporary hybrid power plant generally consists of a diesel driven power module and an energy storage unit.

## How does it work?



Less emissions,  
less noise,  
more benefits.

# Accessories

- Fuel tanks
- Transformers
- Cables
- Load bank
- Distribution boards
- Etc

**“We offer more than just power equipment. We deliver powerful solutions. Perfectly adapted to the constraints of your operations. To power your project forward.”**

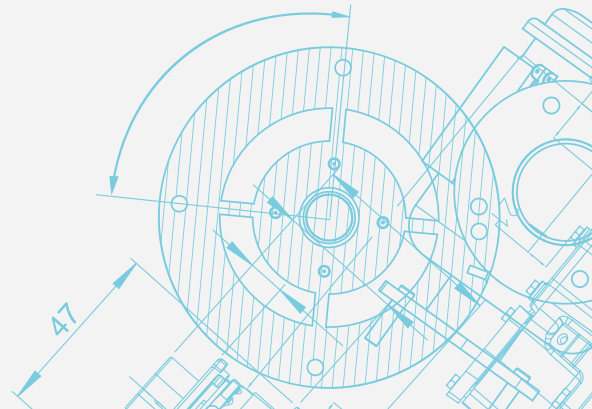



# Fleet

While we focus on “total solutions”, rather than individual units, we do want to share the necessary details of our fleet. We match industry specific rental demands with the equipment and the right accessories to your exact application. Whether for straightforward use or complex projects, small and large: [call Atlas Copco Rental](#).

“Atlas Copco Rental has a future-proof fleet available today.”





Offshore? Of course! Our ability to provide power solutions doesn't stop at the beach.





# Power

	Prime power @ 400V, 50Hz	Sound pressure level	Dimensions	Weight wet	Capacity of fuel tank
	kVA	FAD (m <sup>3</sup> /min)	l x w x h (mm)	kg	L
QAS 150	150	69	3380 x 1200 x 1700	2610	313
QAS 250	250	69	3700 x 1200 x 1800	3400	477
QAS 325	325	69	4000 x 1400 x 2000	4735	603
QAS 400	400	70	4000 x 1400 x 2000	5035	640
QAS 500	500	71	4800 x 1550 x 2300	6445	905
QAS 630	630	71	4800 x 1550 x 2300	6830	911
PM1500 TwinPower	1446	71	6060 x 2440 x 2590	17500	1610



<b>General technical data</b>		<b>ZBC 250-575</b>
Nominal rated power	kW / KVA	250 / 250
Nominal energy storage capacity	kWh	576
Rated voltage (50Hz)*	VAC	400
Battery system voltage	VDC	768
Nominal rated current	A	360
Operating temperature	°C	-20 to 60
Sound power level	dB(A)	<80
<b>Battery</b>		
Quantity	Units	42
Cell chemistry		Lithium iron phosphate LiFePO4
Nominal Voltage	VDC	76,8
Nominal capacity @ 25°C	Ah	250 / 19,2
DoD % (depth of discharge)	%	90 (recommend)
Energy density	Wh / Kg	136
Overcurrent capability		Up to 1,25 x nominal current
<b>Inverter</b>		
Quantity	Units	5
Total peak power	kW	275
Charger voltage	VDC	716,8
Total charger capacity	A	116
Max passthrough current	A	NA
<b>Dimensions and weight</b>		
L x W x H	mm	2991 x 2438 x 2896
Weight	Kg	12000





Contact us now:  
[www.atlascopcorental.com](http://www.atlascopcorental.com)

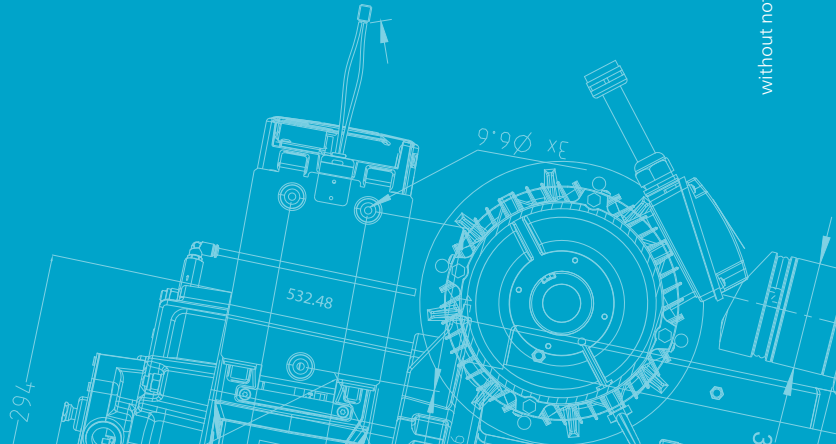

January 2023 © Atlas Copco Rental Europe NV, Belgium.  
All rights reserved. Designs and specifications are subject to change  
without notice or obligation. Read all safety instructions in the manual before usage.