

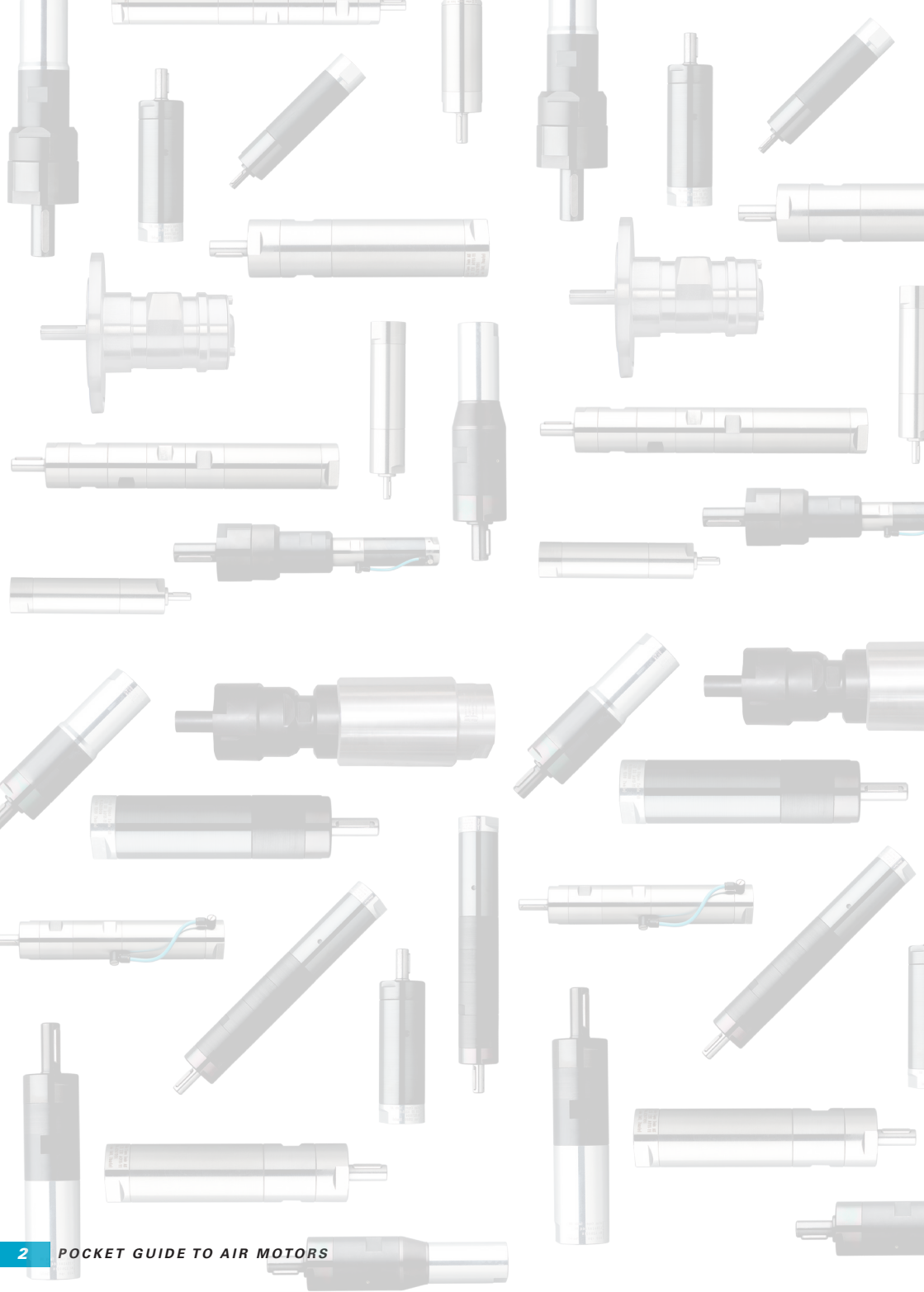

***Pocket guide
to Air motors***

Atlas Copco



CONTENTS

Chapter	Page
1. Introducing the air motor.....	4
2. Design and working principle	6
3. The performance of an air motor.....	10
4. The use of gear units	13
5. Shaft loading.....	13
6. Methods of modifying motor performance	14
7. Using catalogue performance data	16
8. How to choose the right motor	17
9. Silencing.....	22
10. Installing your air motor.....	23
Appendix	27



1. INTRODUCING THE AIR MOTOR



The air motor is one of the toughest and most versatile power units available to the design engineer. The features and characteristics of the air motor make it the natural choice of power for industrial applications, present and future.

Compact and lightweight

An air motor weighs only 1/4 as much as an electric motor with the same output and occupies only 1/6 of the space. Air motors develop far more power in relation to their size and weight than most other motor types.

Torque increases with load

The output of an air motor is relatively constant within a wide speed range – when an increase in load lowers the speed the torque increases.

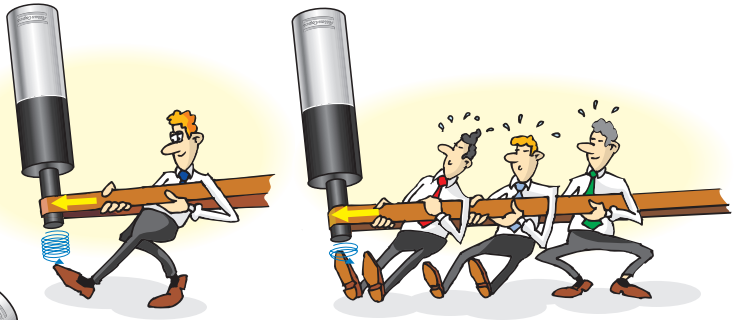

Steplessly adjustable power output

The torque and output of an air motor can be adjusted steplessly by varying the working pressure. Moreover, speed can be adjusted steplessly throughout its entire range by varying the air flow.



Undamaged by overloads

Air motors can be stalled indefinitely without overheating or sustaining any other type of damage. They can also be started and stopped repeatedly without limit.

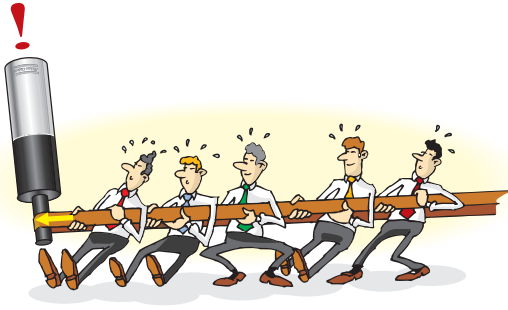

Ideal in hazardous and hostile environments

Since air motors do not generate sparks they are ideal in areas where there are explosion and/or fire hazards. Moreover, their rugged design and construction make them ideal in salt-laden and other corrosive atmospheres.



Easily reversed

Air motors work efficiently in either direction. They are easily reversed using a directional valve.

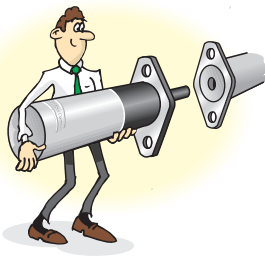

Simple to install

Air motors can work in any position. The motors and the required air lines are easy to install.



Rugged

Air motors are virtually unaffected by heat, vibration, corrosion or knocks and blows. Their performance in hostile environments cannot be matched by other types of motors.

2. DESIGN AND WORKING PRINCIPLE

There are several types of air motor. The most commonly used types are vane, piston and turbine motors. This pocket guide deals with vane motors only. Vane motors are produced with power ratings up to approximately 5 kW.

Design

- A slotted rotor rotates eccentrically in the chamber formed by the cylinder and cylinder end plates.
- Since the rotor is off-center and its diameter smaller than that of the cylinder, a crescent-shaped chamber is created.
- The rotor slots are provided with vanes that move freely to divide the chamber into separate working chambers of different sizes.
- As a result of the centrifugal force, which is often reinforced by the compressed air, the vanes are forced against the cylinder wall to seal the individual chambers.
- The actual efficiency of these seals is a function of what is called "internal leakage".

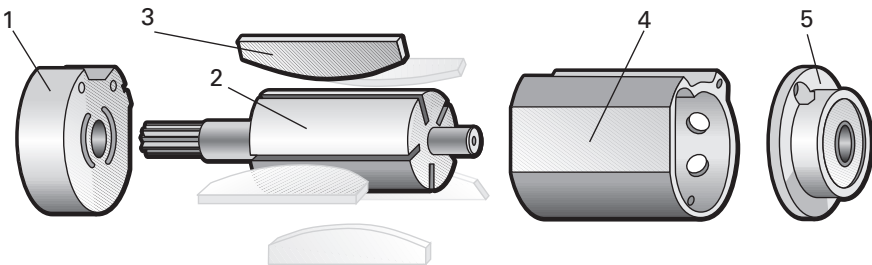

The vane motor has a basic design and consists of only a few components.

1. Front end plate
2. Rotor
3. Vane
4. Cylinder
5. Rear end plate

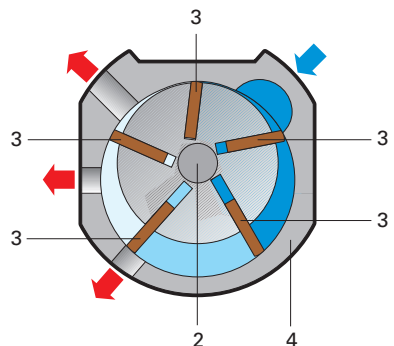

Working principle

- A. The air enters the inlet chamber "a". Vane 2 has just sealed off the chamber "b" between itself and vane 3. The pressure in chamber "b" is still the inlet pressure. This pressure acts on vane 3, moving it in a clockwise direction.
- B. The vanes have rotated further and the expansion process in chamber "b" has started. The pressure in it is thereby reduced but there is still a net force moving the rotor forward as the area of vane 3 is larger than the area of vane 2 in chamber "b". Furthermore the inlet pressure acts on vane 2 in the inlet chamber "a".
- C. The vanes have moved further. Chamber "b" is now being emptied through the outlet and there is no more contribution from this chamber. The force moving the rotor forward now comes from the force on vane 1 and vane 2.

Thanks to this simple principle the energy of the compressed air is converted into rotational motion from chamber to chamber, and the motor turns.

LZB: Clockwise/counter clockwise/reversible

The motor turns in a clockwise direction as seen from the rear end. Besides this type of vane motor there are also counter clockwise and reversible motors. Counter clockwise motors are designed the same way as the clockwise motors but the cross section is mirrored.

For a reversible motor port "a" is the inlet at clockwise rotation. Port "c" is the main outlet and port "b" is the secondary outlet. At counter clockwise rotation port "b" becomes the inlet and port "a" the secondary outlet. Port "c" remains the main outlet. The LZB motors are designed as described above.

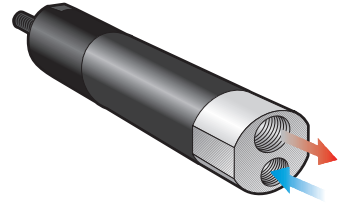

Working principle of an air motor.

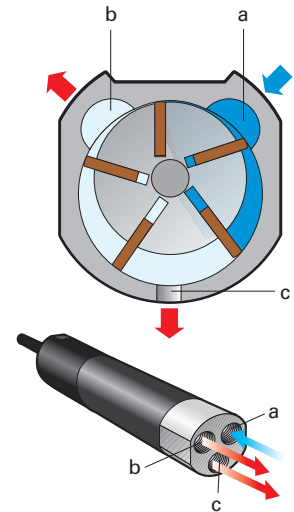

Reversible motors have three air ports.

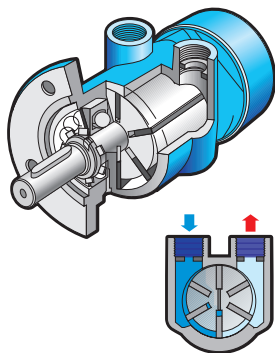

LZL motors represent another type of vane motor.

LZL motors

These motors are reversible but have only two air ports. One is the inlet and the other the outlet. LZL motors are designed to obtain excellent starting and low speed characteristics. This is achieved by 6 vanes that are pushed out to the cylinder wall by rods under the vanes. To support this function LZL motors also have compressed air fed under the vanes.

Rotor speed

During starting and at slow speeds, some of the compressed air flows under the vanes to press them against the cylinder wall and seal the various working chambers. When the rotor rotates, the vanes are forced against the wall of the cylinder by centrifugal force. At high speeds, however, the pressure exerted against the wall by the vanes must not be too great, or excessive wear will result.

The amount of wear is a function of the third power of the sliding speed between the tip of the vane and the cylinder wall and, in actual practice, this determines the maximum rotational speed.

In order to keep the centrifugal force down, high-speed motors, or rather their rotors, are long and slim and equipped with only three or four vanes.

Number of vanes

The number of vanes in the motor, which can range between 3 and 10, is an important design consideration. In general, the fewer the vanes, the lower the losses due to friction, but this also means that starting may be more difficult. If more vanes are provided, starting is easier and internal leakage lower, but there is more friction.

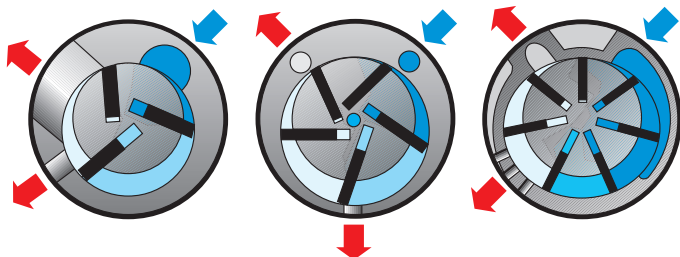

The number of vanes in the motor depends on which application the motor is designed for.

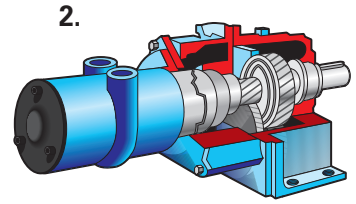
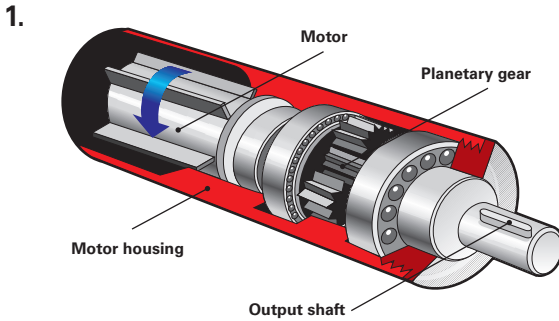

Planetary gear (1), helical gear (2).

Gears

The rotor of a vane motor turns at quite high speed. The free speed of an LZB motor is typically around 20 000 rpm. LZL motors have free speeds from around 6 000 to 9 300 rpm. For most applications these speeds are too high and the rotor torque is also rather small. To convert a high speed and low torque to lower speed and higher torque, gears are used. Atlas Copco's vane motors are supplied with different types of gears: Planetary gears and helical gears. (See appendix.)

Lubrication free motors



The traditional vane motors are lubricated by the compressed air to which a small amount of oil is added. Lubrication free motors do not need any oil added to the air. These motors are equipped with vanes made of a special low friction material and have permanently lubricated bearings. When long service life is the first priority lubricated motors should be chosen because their vanes last longer.

Motors with brakes

The most popular vane motors, type LZB 33, are available with parking brakes. The brake is located between the motor and the gear. It is a disc brake that is spring activated when the motor is not running. When the motor is started the brake is released by a built-in pneumatic piston. The brake is used when it is important that the output shaft must not turn when the motor isn't running and a torque is applied on the shaft.



Motor with brake.

3. THE PERFORMANCE OF AN AIR MOTOR

The performance of an air motor is dependent on the inlet pressure. At a constant inlet pressure, air motors exhibit the characteristic linear output torque/speed relationship. However, by simply regulating the air supply, using the techniques of throttling or pressure regulation, the output of an air motor can easily be modified.

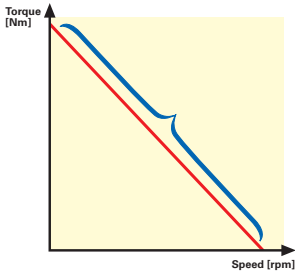

The motor can operate over the complete torque curve.

One of the features of air motors is that they can operate over the complete torque curve from free speed to standstill without any harm to the motor. The free speed or idling speed is defined as the operating speed where there is no load on the output shaft.

Free Speed = speed at which the outgoing shaft rotates when no load is applied.

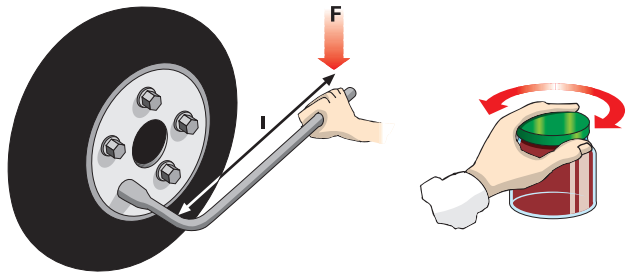

Torque is the rotating force that is calculated as force (F) times the length (l) of the lever.

The power curve

The power that an air motor produces is simply the product of torque and speed. Air motors produce a characteristic power curve, with maximum power occurring at around 50% of the free speed. The torque produced at this point is often referred to as “torque at the maximum output.”

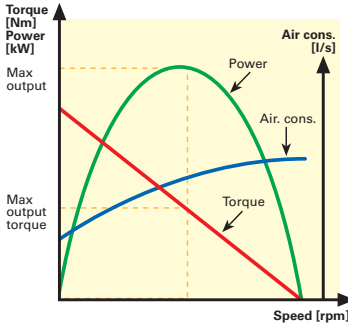

Output formula

$$P = (\pi \times M \times n) / 30$$
$$M = (30 \times P) / (\pi \times n)$$
$$n = (30 \times P) / (\pi \times M)$$

$P = \text{power [kW]}$
 $M = \text{torque [Nm]}$
 $n = \text{speed [rpm]}$

The performance curve for an air motor operating at a constant air pressure.

The working point

When selecting an air motor for an application the first step is to establish the “working point.” This is the combination of the desired operating speed for the motor and the torque required at that point.

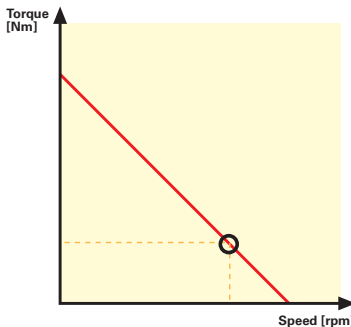

The point at the torque/ speed curve where the motor actually operates is called the working point.

The working point for an air motor.

Air consumption

The air consumption for an air motor increases with the motor speed and thus is highest at free speed. Even at standstill condition (with full pressure applied) the motor consumes air. This depends on the internal leakage in the motor.

Air consumption is measured in l/s. This is however not the actual volume that the compressed air occupies in the motor but it is measured as the volume it would occupy if allowed to expand to atmospheric pressure. This is a standard used for all pneumatic equipment.

The starting torque is the torque that a motor gives with blocked shaft when you feed full air pressure into it.

Starting torque

It should be noted that all vane air motors produce a variable starting torque due to the position of the vanes in the motor. The lowest starting torque value is called the minimum starting torque and can be considered as a guaranteed value at start up. The variation differs between motor types and must be checked on an individual basis. It is notable that the torque variation is greater for reversible motors than for non-reversible motors and therefore the minimum starting torque is smaller for these motors.

Stall torque

The stall torque is the torque that a motor gives just when it stops after being braked to a stop from a running condition. The stall torque is not stated among the tabulated data. However multiplying the maximum power torque by two can easily approximate the stall torque, i.e., a maximum power torque of 10 Nm equals a stall torque of approximately 20 Nm.

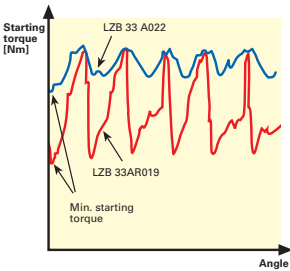

At start up the torque varies with the vane position.

Stall torque is the torque provided when the motor is run to standstill.

The stall torque varies depending on how fast the motor is braked down to stall. A fast braking results in higher stall torque than a slow braking down. This depends on the fact that the mass (moment of inertia) from the rotor increases the torque.

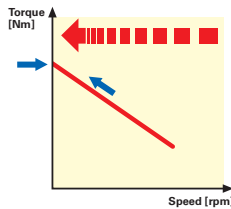
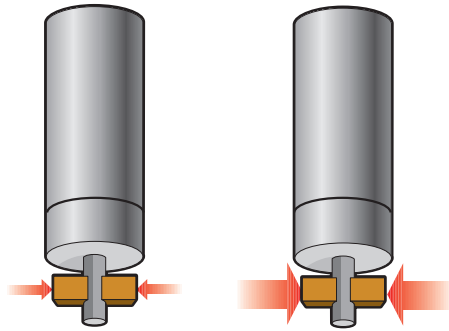

Slow braking.

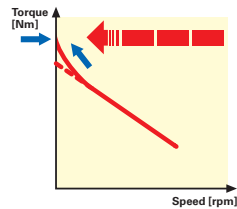

Fast braking.

4. THE USE OF GEAR UNITS

Air motors operate at high speeds and although they can be controlled over a wide speed range, the output characteristics are not always suitable for the application. To achieve the required output an appropriate gear unit can be selected.

The planetary and helical gear units used by Atlas Copco have a high level of efficiency that can be assumed to be 100%. Evidently, while the torque/speed relationship undergoes a considerable change, the power output remains virtually unchanged. The torque is increased and the speed is reduced proportional to the gear ratio.

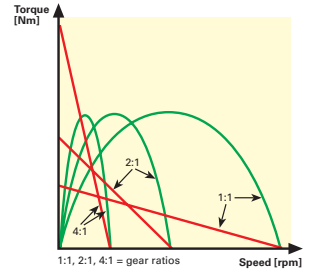

Speed and torque can be changed by using gears.

5. SHAFT LOADING

Shaft loading on an air motor affects bearing life.

The Atlas Copco Air Motor Catalogue contains curves giving maximum shaft loads for working lives of 10 million turns. These curves indicate the maximum permitted combination of radial and axial load.

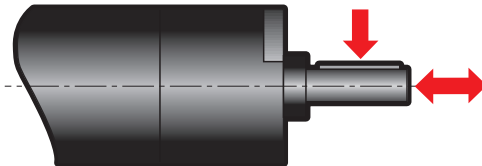

Shaft load influences bearing life.

6. METHODS OF MODIFYING MOTOR PERFORMANCE

Two methods can be used to modify the performance of an air motor. Throttling and/or pressure regulation. The conditions for the application decide which method is the preferred one.

The free speed and torque can be regulated down to 50% for the LZB air motor. The free speed for an LZL can be regulated down to 10% and the torque can be regulated down to 20%.

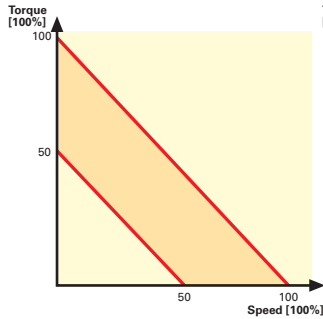

The LZB air motor can operate anywhere within the shaded area.

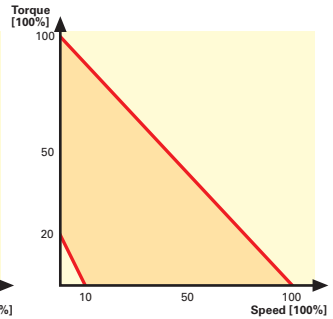

The LZL can operate at very low torque and speed as indicated by the shaded area.

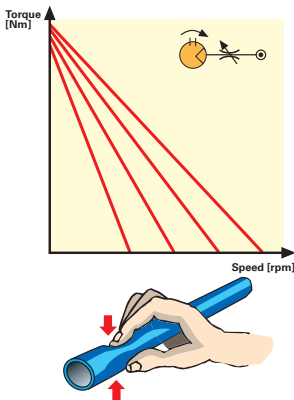

Throttling is synonymous with air flow control and affects speed more than torque.

Throttling

A throttle is usually fitted into the motor's inlet, although it can also be fitted into the exhaust. The benefit of throttling the inlet is that air consumption is reduced, whereas throttling the exhaust air maintains a slightly higher starting torque. When it is desirable to maintain a high starting torque but reduce running speed, throttling is the best method of modifying the motor's output.

Pressure regulation

When using a pressure regulator it is always fitted into the inlet of the motor. The use of pressure regulation is ideal when control of the stall torque is required and a high starting torque is unimportant.

Motor performance with other air pressures

All performance graphs of Atlas Copco air motors are given for an inlet pressure of 6.3 bar. For other air pressures the performance curves must be recalculated. To calculate performance data the motor data at 6.3 bar has to be multiplied by the correction factor shown in table 1.

Correction factors					
Air pressure (Bar)	Air pressure (Psi)	Output	Speed	Torque	Air consumption
7	101	1.13	1.01	1.09	1.11
6	87	0.94	0.99	0.95	0.96
5	73	0.71	0.93	0.79	0.77
4	58	0.51	0.85	0.63	0.61
3	44	0.33	0.73	0.48	0.44

Another way to find out how to pressure regulate or throttle motors is to use the Air Motor Selection Program which is available into www.atlascopco.com/airmotors

Log in to www.atlascopco.com/airmotors

24-hour access

Visit our website and browse through our on-line catalogue. You'll find comprehensive technical information as well as details of accessories, spare parts and dimensional drawings. You can also subscribe to our news.

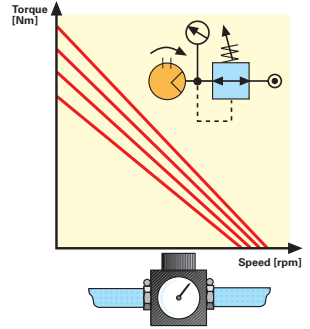

Pressure regulation affects torque more than speed.

Table 1



Re-calculation is easily done with the selection program.



7. USING CATALOGUE PERFORMANCE DATA

The performance data stated in Atlas Copco Air Motor Catalogues is valid for an air supply pressure of 6.3 bar (91 psi), gauge. The data in the catalogue is available both in tables and diagrams.

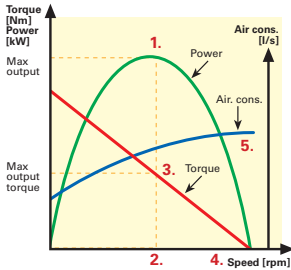

A number of key data are identified in the diagram. These data are also listed in the data tables of the motors in the catalogue.

The output of an air motor is most clearly seen from its performance diagram. For each motor/gear unit the power, torque and air consumption are shown as a function of speed.

1. Maximum power, kW and hp
2. Speed at point of maximum power, rpm
3. Torque at maximum power, Nm
4. Free speed, rpm
5. Air consumption at maximum power, l/s

The starting torque produced by an air motor is variable and depends on vane position. This information can only be obtained from data tables, where the guaranteed value is shown. The stall torque is not given in the catalogue data but can be estimated as twice the torque at maximum power output.

8. HOW TO CHOOSE THE RIGHT MOTOR

When selecting the right motor for any given application, it is advisable to consider what needs must be satisfied. A good way to do this is by using the step-by-step process described below.

General rules for selecting air motors

The wide operating range of an air motor makes it probable that a number of different motors could run at the same working point. Your choice of motor will be influenced by where you find the working point on the torque-speed curve.

Because it is most efficient to run the motor at the speed of maximum power, selecting the one that produces maximum power as close to the working point as possible will give you the smallest possible alternative. This motor will also give the lowest air consumption for a given power output.

If stable speed of the air motor is important you should avoid working with speeds below the point of maximum power. This assures that there is some “reserve power” in the case of load increase. It is also a good idea to work closer to the idling speed when there is uncertainty about the torque demand.

Low speed/high torque makes the load on the gears high. High speeds affect the lifetime of the vanes.

If a very long lifetime is demanded, a large motor that is restricted or run at a low pressure should be chosen.

- Low starting torque
- Instable speed
- Low air consumption
- High load on gears
- Low vane wear

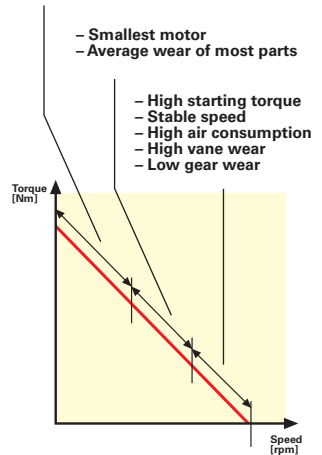

Different working point areas.

Example 1:

A non-reversible motor is required to run at 300 rpm and produce a torque of 10 Nm. Select the most suitable motor for this application.

1. In the example the required power is $P = 3.14 \times 10 \times 300 / 30 = 314 \text{ W}$ (0.314 kW)
2. Select a motor type with the right power output from the air motor catalogue or the selection program. In this case we choose the LZB 33 (0.39 kW)
3. Look at the performance curves for each motor variant and select the one that has its maximum power nearest to the working point.
4. The two motors that best match the demand are LZB 33 A005 and LZB 33 A007. The first choice should be A005 as we then work with a speed above the maximum power point and thereby give a higher starting torque and more stable speed.
5. When the working point is plotted, it is often noted that the motor has to be slightly adjusted for the working point to coincide with the performance graph. This can be done in two ways, adjusting air flows or air pressure.

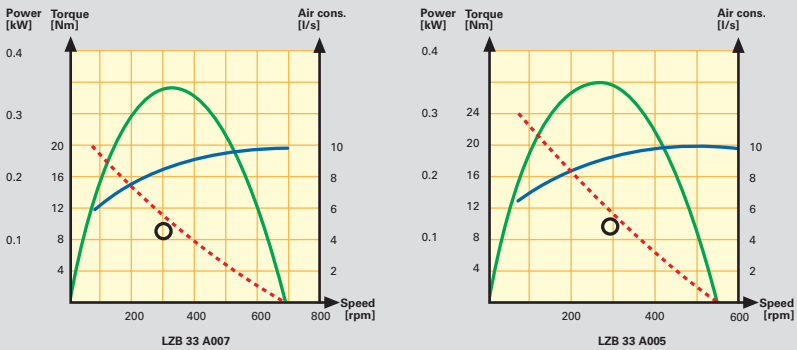

As seen in the performance graphs we have a choice between LZB 33 A007 and LZB 33 A005.

Different operating parameters

Normally operating parameters are adequately described by giving the required torque and corresponding speed. Six common additional requirements frequently occur:

- Starting torque
- Stall torque
- Free speed
- Service life
- Air consumption
- Shaft loading

The motor must produce a certain torque at start up

Many applications demand that a motor produce at least a threshold torque at start up. This can be the case when a motor is to move a load. The minimum starting torque for a given motor has to be looked up in the tabular data.

Example 2:

An air motor is to be used to operate a trolley. The working point for the motor is $M = 20 \text{ Nm}$ at $n = 150 \text{ rpm}$. Since starting characteristics are essential the motor also has to have a starting torque of 35 Nm .

The power requirement will be: $P = 3.14 \times 20 \times 150 / 30 = 314 \text{ W}$ (0.314 kW)

The correct motor size for this application is the LZB 42 (0.53 kW) according to the Air Motor Catalogue selection program.

The performance graphs show that the LZB 42 AR004 meets the requirements for the working point. However, when we consider the demand that the minimum starting torque is to be 35 Nm , we see from the catalogue that the motor does not fulfil this demand as it can only guarantee a minimum starting torque of 26.8 Nm .

We must choose a motor with another gear ratio. As we need a higher starting torque we consequently need a motor with a higher gear ratio. The LZB 42 AR0025 has a minimum starting torque of 44 Nm and is a good choice for this application.

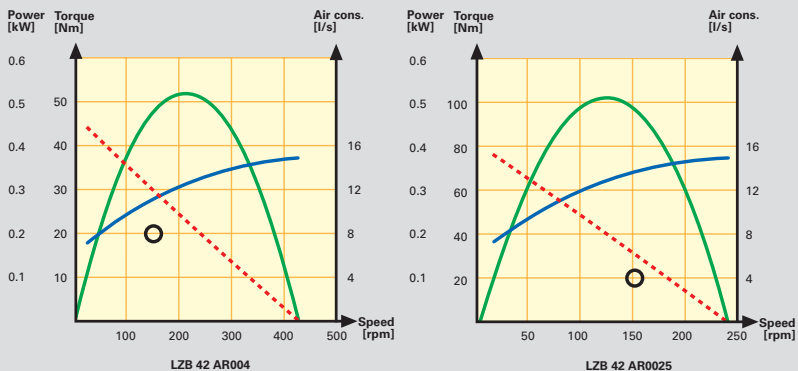

The LZB 42 AR004 matches the requirement for the working point but does not fulfill the minimum starting torque requirement. Therefore we choose the LZB 42 AR0025 instead.

The motor must reach a specified stall torque and also a specified free speed

Two common applications for air motors are strapping tools for packaging and tools for assembling threaded joints. Both these applications place demands on free speed and stall torque. The free speed defines how fast the process will be. This is because much of the time the motor is working at low torque, such as when taking up the slack during strapping and the rundown during screw fastening. The stall torque defines the tension in the strap and the installed torque of the threaded joint.

Example 3:

We assume that we are looking for a nutrunner motor that can tighten a nut to 25 Nm and can run down the free spinning nut at a speed of 500 rpm. In this case the motor must not be reversible.

The stall torque is not specified in our catalogues but it is easy to calculate because it is twice the maximum power torque. We also know that the free speed is twice the maximum power speed. That means that we should look for motors with at least 12.5 Nm maximum power torque and 250 rpm maximum power speed.

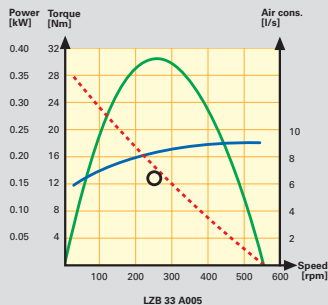

LZB 33 A005 will be a good choice for the nutrunner application.

This requires a motor with $(3.14 \times 12.5 \times 250) / 30 = 327 W$ which guides us to start looking among the non-reversible LZB 33 motors. We find a motor that looks suitable, LZB 33 A005. It has maximum power torque 14 Nm (stall torque 28 Nm) and free speed 550 rpm at 6.3 bar.

If we must have exactly 25 Nm stall torque we must adjust the torque down a little. Reducing the pressure slightly with a pressure regulator should do this.

Pressure regulation will also take down the speed a little but less than if you restrict the airflow and we will still be above 500 rpm.

Service life

The service life of a motor is highly dependent on the working conditions. If the working cycle is a mix of free running, running at maximum power and braking down to stall, the service life of lubricated vanes for LZB type motors is typically 2 000 hours and lubrication free vanes 1 000 hours. or LZL type motors with lubricated vanes the service life is typically 2 000 hours, with a typical service life of 500 hours for lubrication free vanes.

To determine the service life more exactly we recommend an initial inspection based on the above recommended time intervals. The Product Instructions supplied with the motor specify the maximum allowed vane wear for each motor type and size. A change of vanes is recommended before the wear exceeds these values. The Product Instructions are also available electronically via Servaid on the web.

Example 4:

The application is running a paint stirrer at torque 20 Nm and speed 150 rpm. It runs for 8 hours per day, which puts high demands on service life.

The working point tells us that the power must be at least $3.14 \times 20 \times 150 / 30 = 314 \text{ W}$. One motor that satisfies this working point is LZB 33 A0030.

When we have 8 hours running per day we should oversize the motor and adjust down the performance by pressure regulation or flow restriction. Therefore we look at the LZB 42 motors where we find a number of motors that satisfy the working point. LZB 42 A005 is one alternative. We find that the speed at the working point is very low compared with the free speed, this indicates long service life of the vanes. On the other hand the torque is about equal to the maximum power torque which can limit the lifetime of the gears. Therefore a motor that looks more suitable is LZB 42 A0030. With this motor the working speed is around half the free speed and the torque is around half the maximum power torque. It means that we will get long service life for both vanes and gears. To reach the working point in this case you can either reduce the air pressure or restrict the airflow.

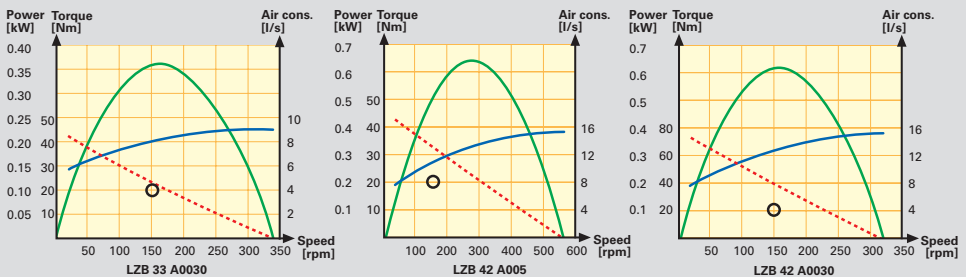

An oversized motor will give long service life.

Air consumption

When low air consumption is a major concern you should as first priority try to find the smallest possible motor. If you have decided on a motor size and have different options within this size you should be aware of the fact that the closer the motor works to its free speed, the higher the air consumption will be. If you choose to adjust down the performance of a motor you will get the lowest air consumption by airflow restriction (on the motor inlet) rather than pressure regulation.



Shaft loading

The maximum allowable shaft load is specified for each motor in the Air Motor Catalogue. In the data tables shaft loading codes are listed. These codes point to curves where the allowed combinations of radial and axial shaft load are defined. It is a good idea to check that the application will not give shaft loads above what we allow. In some rare cases you might have to choose an oversized motor just to be able to manage the shaft loads.

9. SILENCING

The noise generated by an air motor is mainly caused by the exhaust air exiting the motor. The noise level increases with speed and is greatest at free speed.

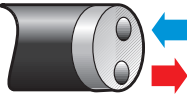
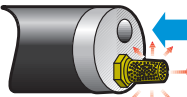
All Atlas Copco motors are supplied with a threaded exhaust port permitting a screw-in silencer to be fitted to reduce noise level. By fitting a hose between the exhaust port and the silencer the noise level can be reduced even further. The effect of employing the various silencing techniques is indicated in table 2. Note that a silencer may cause power losses if incorrectly sized.

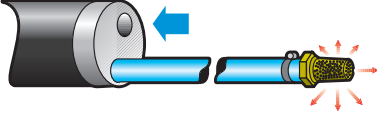
<i>0.36 kW motor No-load speed Anechoic room Interval of 1 minute</i>	<i>Measure</i>	<i>Noise Level dB (A)</i>
	<i>None</i>	<i>94</i>
	<i>Silencer Only</i>	<i>77</i>
	<i>Hose Only</i>	<i>84</i>
	<i>Hose with Silencer</i>	<i>75</i>

Different noise reduction possibilities and the effects thereof: the noise values are fictitious and only relevant in relation to one another.

Table 2

10. INSTALLING YOUR AIR MOTOR

An air motor needs a certain amount of air and a certain pressure to function. Supply and exhaust hoses must therefore be properly dimensioned.

Air lines

Using air lines that are too long or under-dimensioned will result in pressure drops. As stated earlier in this guide, this means power losses. The exhaust line must have a larger dimension than the supply line. This is because the exhaust air occupies a larger volume than the supply air. For an inlet pressure of 6.3 bar (= 7.3 bar absolute) and an outlet pressure at atmospheric level (= 1 bar absolute) the volume increase is a factor of 7.3. In practice this means that if the same dimensions are used for inlet and outlet lines a back pressure is built up and the motor loses its efficiency.

Motor size	Rotation	Inlet connection thread (BSP)	Inlet connection thread (NPTF)	Inlet hose* [both inlets on reversible] (mm)	Inlet recommended nipple connection (ordering number)	Inlet nipple* (mm)	Outlet connection thread (BSP)	Outlet hose* (mm)	Outlet recommended nipple connection (order number)	Outlet nipple* diameter (mm)
LZB14	A, AV, AR	1/8"	-	8	9900 0240 00	5.0	1/8"	8	9900 0240 00	5.0
LZB22	A, AV	1/8"	-	8	9900 0240 00	5.0	1/4"	10	9900 0247 00	8.0
LZB22	AR, LR	1/8"	-	8	9900 0240 00	5.0	1/8"	8	9900 0240 00	5.0
LZB33, LZB34	A, AV, AR, LR	1/4"	-	10	9900 0247 00	8.0	1/4"	10	9900 0247 00	8.0
LZB42	A, AR	1/4"	-	10	9900 0247 00	8.0	1/2"	16	9900 0244 00	13.4
LZB46	A, AV, AR	1/4"	-	10	9900 0247 00	8.0	1/2"	16	9900 0244 00	13.4
LZB54	A, AV, AR	3/8"	-	13	9900 0248 00	9.3	1/2"	16	9900 0244 00	13.4
LZB66	A, AR	3/8"	-	13	9900 0248 00	10.3	3/4"	20	9900 0245 00	17
LZB77	A, AR	1/2" **	1/2"-14	16	9900 0244 00	13.4	-	-	-	-

* recommended minimum inner diameter

** alternative connection thread BSP 1/2" delivered with the product

Table 3.
Hose size up to 3 m length.

Remember: When selecting an air preparation package, ensure all components have a flow capacity sufficient to meet the requirements of the motor.

Air preparation

To ensure reliable service an air filter and lubricator (if the motor is not lubrication free) should be fitted into the inlet air-line – within 5 meters from the motor. It is recommended that a pressure regulator is also incorporated into the air preparation package. This has the function of maintaining the desired working pressure, and can be used to modify the output exactly to meet the needs of the application.

Lubrication

To achieve optimum service life and performance an air motor should be supplied with 50 mm³ of oil for each cubic meter (1 000 liters) of air consumed. Insufficient lubrication will result in accelerated vane wear and a reduction in performance. The following example shows how to calculate the lubrication required by a motor running at a known output.

Example:

A non-reversible LZB 33 motor running at maximum output consumes 8.3 liters//sec. of air. In one minute it consumes 498 (8.3x60) liters of air, therefore the lubrication required is: $498/1\ 000 \times 50 = 25\ \text{mm}^3/\text{min}$. If an oil-fog lubricator is used it should be set to deliver 2 drops of oil per minute (1 drop = 15 mm³). The lubricator oil selected should have a viscosity of between 50 and 300x10⁶ m²/s at the working temperature.

Directional control valves

These valves are used to start or stop a motor, or to change its direction of rotation. It is most usual to use what is termed as a 5/3 valve to control a reversible motor, and a 3/2 valve to control a non-reversible motor.

The valve designations refer to the number of connection ports and the number of operating positions the valve provides. For a 5/3 valve this is 5-connection ports and 3 positions.

When selecting any control valve it is important to ensure that it has a flow capacity that is sufficient to supply the requirements of the motor.

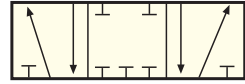
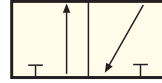

The symbols used to represent these valves on an installation diagram.

Installation examples

Typical installation diagrams for type LZB and LZL air motors, together with their associated control valves, filters, regulators, lubricators silencers and mufflers.

LZB Circuits

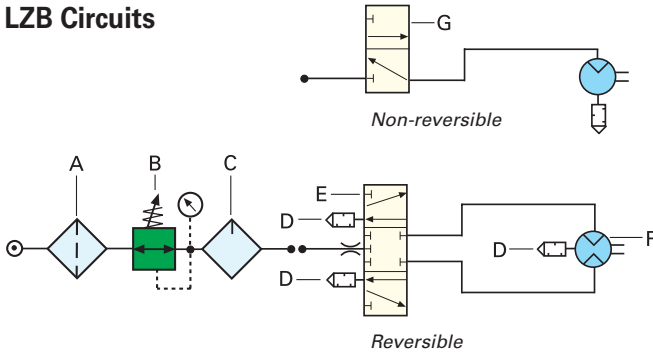

- A = Filter
- B = Pressure regulator
- C = Oil fog lubricator
- D = Silencer
- E = 5/3 valve
- F = Air motor
- G = 3/2 valve

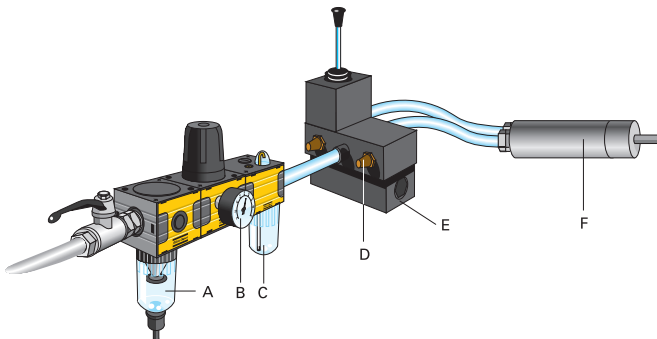

The direction of rotation is controlled manually by a lever-operated 5/3 valve. The air preparation unit ensures that the motor is supplied with clean air and lubrication. The built-in pressure regulator can also be used to modify the output of the motor.

LZL Circuits

Non-reversible duty with 3/2 valve.

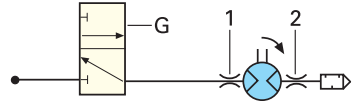

Reversible duty with 5/3 valve and closed mid position.

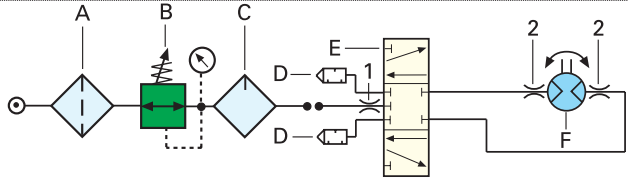

Reversible duty with 5/3 valve and open mid position.

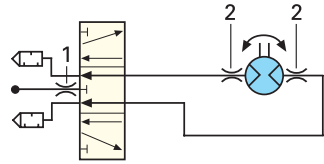

- A = Filter
- B = Pressure regulator
- C = Oil fog lubricator
- D = Silencer
- E = 5/3 valve
- F = Air motor
- G = 3/2 valve

- 1 = Inlet restrictor
- 2 = Outlet restrictor

For LZL air motors it is important that an inlet restrictor is located upstream of the inlet. It must be positioned so that it does not affect the exhaust during reversible running. This means that it has to be placed before the control valve.

Appendix

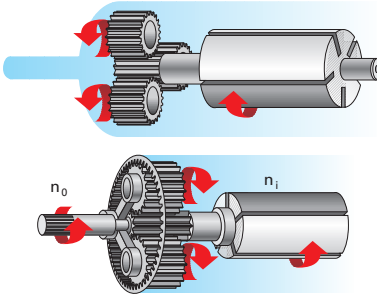

Planetary gears

Planetary gears are used when small dimensions are important because they have high torque capacity for a given size. The main parts in planetary gears are the sun wheel, the planetary wheels, the gear rim and the planet shaft. The planet shaft is the output shaft. The planet wheels are placed on the planet shaft. The outer part is the rear rim that has internal cogs. The gear ratio is calculated using the formula $i = 1 + Z_3 / Z_1$ where Z_1 is the number of teeth on the sun wheel and Z_3 is the number of teeth on the gear rim.

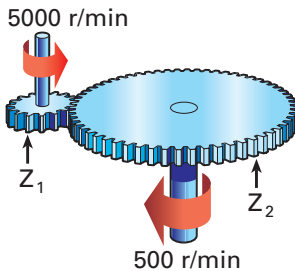

Helical gear

The helical gear is the basic gear type. A single step helical gear has two gear wheels, the primary high speed wheel, pinion, and the secondary low speed wheel. The gear ratio is defined by the number of teeth on the primary and secondary wheels. It is calculated using the formula, $i = n_1 / n_2 = Z_2 / Z_1$ where i = the gear ratio, n_1 = the primary speed, n_2 = secondary speed, Z_1 = number of teeth on the primary wheel and Z_2 = number of teeth on the secondary wheel. High gear ratios require a very big secondary gear wheel. Therefore it is more practical to design the helical gears in more steps when higher gear ratios are desired. Helical gears are used together with the LZL motors.

COMMITTED TO SUSTAINABLE PRODUCTIVITY

www.atlascopco.com

