



Atlas Copco



**Pocket guide on  
adhesive bonding**

## Adhesive bonding the futuristic assembly technology

People often get the wrong idea about adhesive bonding and see it as less effective than fastening or riveting. But, in fact, bonding is one of the most efficient and productive joining technologies.

The demand for products that combine an increasing number of materials, as well as being lighter and cheaper to manufacture, has opened up the market for adhesive bonding.

Bonding using advanced adhesives is an effective option that can replace riveting, welding and threaded fasteners. It is the assembly technology of the future for many crafts and industries, and already widely used in the motor vehicle industry, aerospace, electronics, renewable energy and appliances.

In the automotive and aerospace industries for instance, adhesive bonding is used to join lightweight metals and composites. These are increasingly used to produce lighter vehicles and aircraft and thus reduce fuel consumption and emissions.

# Contents

1. Overview of joining techniques.....	4
2. Historical background.....	5
3. Examples from nature.....	7
4. Definitions: Bonding; Adhesion; Viscosity; Rheology; Wetting .....	8
5. The adhesive joint and its tension distribution.....	16
6. Advantages/disadvantages of bonding.....	18
7. Benefits of bonding.....	20
8. Structural bonding, elastic bonding and sealants.....	22
9. Influences on the bonding function.....	24
10. Importance of surface treatment.....	32
11. Surface energy.....	36
12. Properties of adhesives.....	38
Glossary .....	43

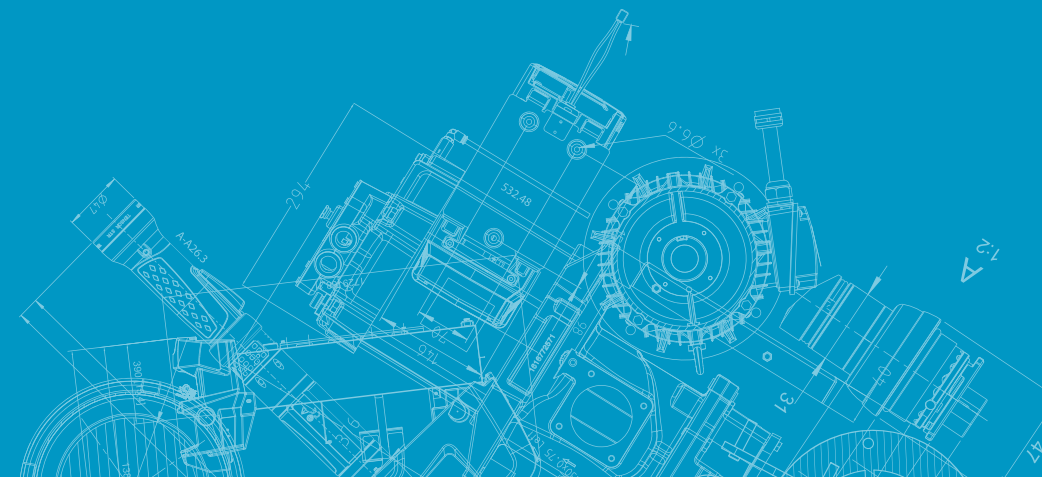

# 1. Overview of joining techniques

Classification of joining methods

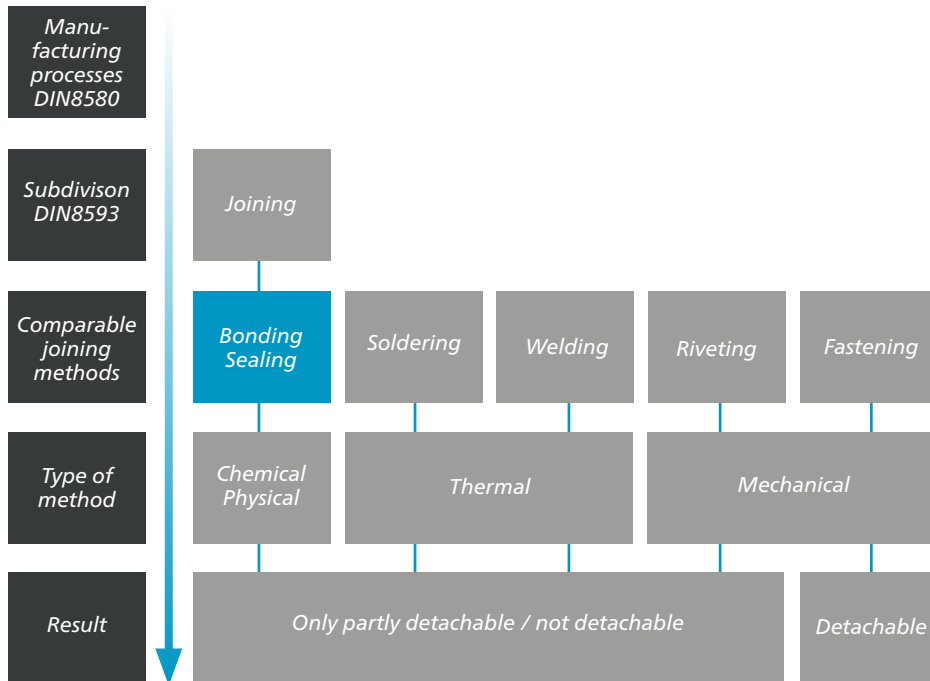

# 2. Historical background

## Material and technology development – the wheel

Since the invention of the wheel in Mesopotamia in 3500 BC, man has continuously striven to improve the smoothness of the ride.

Today's vehicle tires are made from a number of materials, including fabric, steel cord, synthetic fiber and rubber, bonded together using adhesives.

The smooth, quiet ride we enjoy in our cars today would not be possible without adhesive bonding.

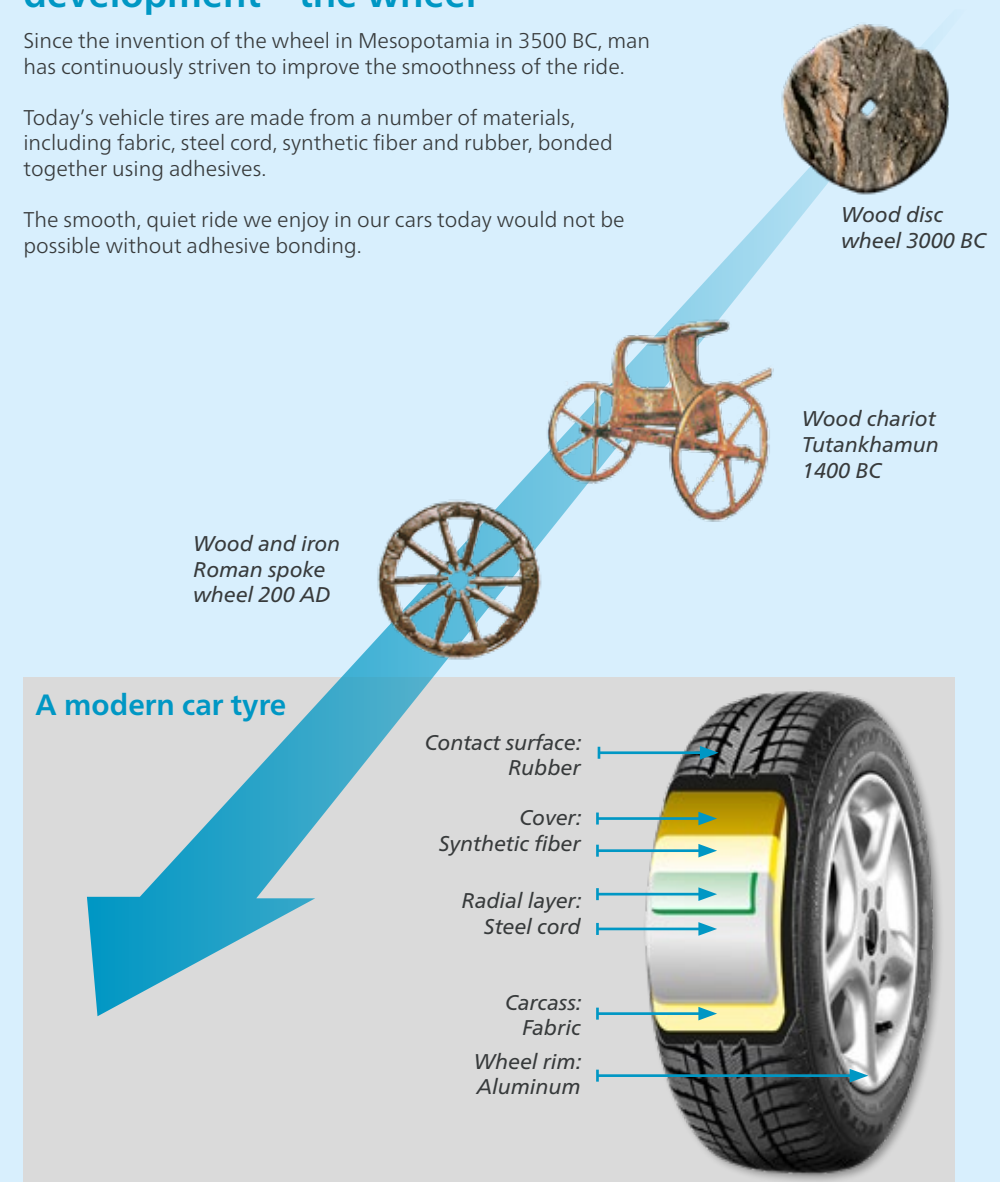

## Adhesives go back a long way

Asphalt/pine resin mixtures, an early form of today's hot-melt-type adhesive were in use as early as the building of the Tower of Babel.

Bonding together materials such as wood, stone, ceramics, etc. with the help of adhesives, glues or putties is something which goes back to the prehistoric age.

Fragments of an alabaster statuette crafted between 3000 and 3300 BC were found in Uruk (Erech). The eyeballs consist of the centre of a mussel, into which pupils of lapis lazuli were stuck by means of adhesive. The glue used was asphalt or glue made from animal products (fish skin/bone glue).



Drops of pine resin.

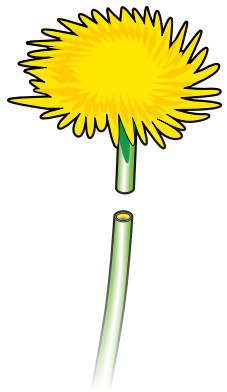

The milky sap of the dandelion.

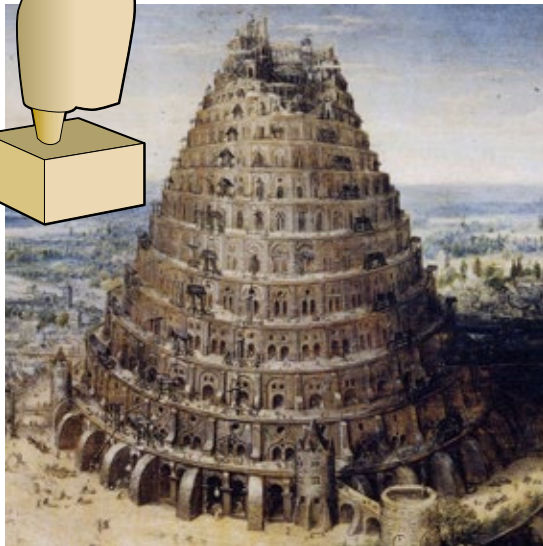
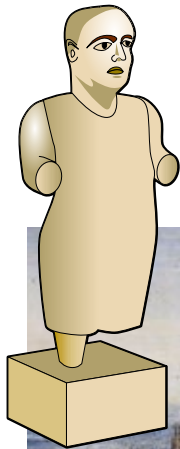

## 3. Examples from nature

### The gecko's adhesive system

Geckos have the remarkable ability to run at any orientation on just about any smooth or rough, wet or dry, clean or dirty surface.

The secret of the gecko's adhesive properties: Millions of micron-scale setae on each toe of the gecko form a self-cleaning dry adhesive.

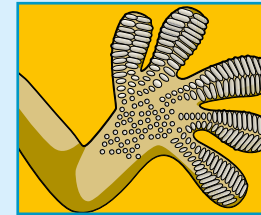

Meso

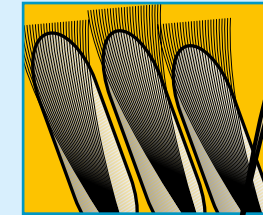

Micro

Nano-structures



Macro

### Sundew – carnivorous plants

These plants use droplets of adhesive to make their prey "stick around" long enough to be digested.

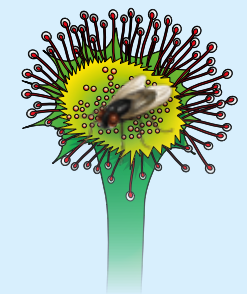



## 4. Definitions

To truly understand the concept of bonding, it is helpful to also understand adhesion, viscosity, rheology and wetting.

### What is bonding?

Bonding is joining two or more substrates using an adhesive.

*Adhesives are used more frequently than people think. Bonding is unconsciously considered by many people as a method of second choice because nailing, fastening or welding seems to be more fixed.*

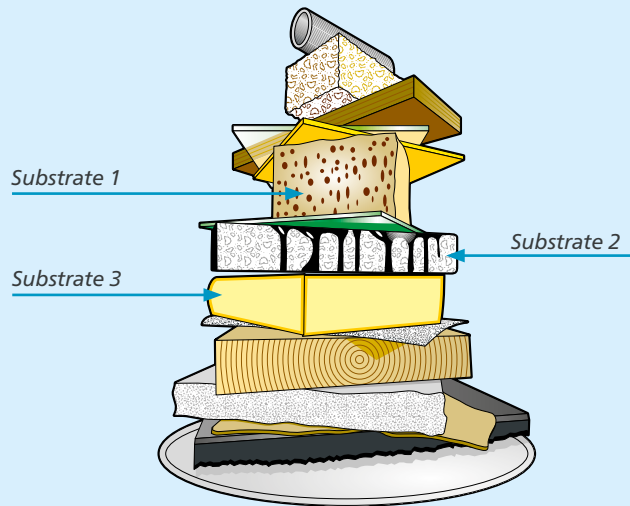

### What is an adhesive?

#### DIN EN 923

An adhesive is defined as a non-metallic binder that acts via adhesion and cohesion.

#### ASTM D907-06

An adhesive is a substance capable of holding materials together by surface attachment.

### Why does an adhesive adhere?

If we succeed in bringing loose molecules close enough together, considerable forces of attraction are effected between them. This force of attraction is called cohesion if the molecules are of the same kind. If the molecules are of a different kind, then it is called adhesion.

#### Examples:

- Water molecules which we cool down move so close together that a firm, hard material is created - ice. If we bring a glass pane into contact with a water surface, then we require considerable force to lift it up again. This is due to the adhesion between glass and water.
- Pressing finely polished surfaces of lead brick onto one another, we recognise a force of attraction which attempts to hold them together. In this case it is cohesion.
- When we use an adhesive, we utilize both cohesion and adhesion. The adhesive must stick to the surfaces we wish to bond because of adhesion and, naturally, the cohesion must hold the adhesive itself together.

#### Why does a thin layer of adhesive achieve better bonding results than a thick layer?

- Strangely, in most cases, the adhesive has greater adhesive force than cohesive force. Therefore, if we use too much adhesive, we increase the possibility that small particles of the adhesive will separate from one another. The bond then fails in the joint's interior.
- But there are exceptions – for elastic bonds we require a layer 3-5 mm thick.

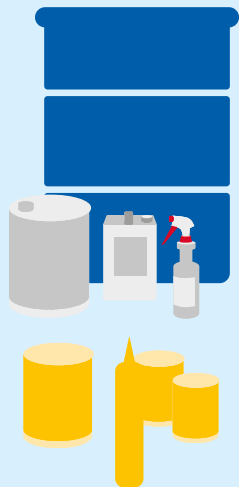



## What is adhesion?

Adhesion can be divided into two categories:

1. Adhesive materials fill the voids or pores of the surfaces and hold them together by mechanical interlocking.

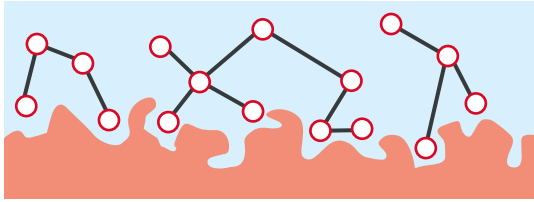

2. Adhesion by effects such as chemical bonds and by interaction forces, such as electrical forces and "Van der Waals" forces.

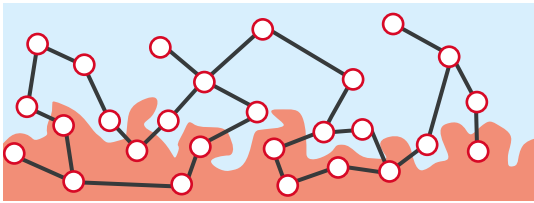

## What is cohesion?

The tendency of similar or identical particles/surfaces to cling to one another. In terms of glues, cohesion forces are responsible for the viscosity and flow properties (rheology) of uncured glues and for the strength of the glue cured when being stressed.

The final strength (maximum cohesion) will be reached after curing.

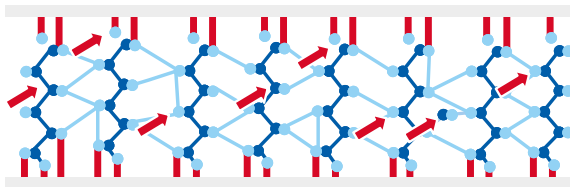

## Viscosity

The resistance of a substance to flow. Viscosity is related to the concept of shear force; it can be understood as the effect of different layers of the fluid exerting shearing force on each other, or on other surfaces, as they move against each other.

From an adhesive bonding perspective, viscosity is important because of its influence on the quality of an application bead.



*Example: Water has a lower viscosity than honey, therefore it flows more easily.*

## Viscosity – its influence

*Pasty adhesives*



*Liquid adhesives*



*Pasty adhesives = high viscosity*

*Liquid adhesive = low viscosity*

## Rheology

Rheology is the study of the flow of matter, primarily in the liquid state, but also as “soft solids” or solids under conditions in which they respond with plastic flow rather than deforming elastically in response to an applied force.

Rheology is important from a bonding perspective because when you apply the material, it should not flow away or fall from the product.

### Newtonian Fluids

These fluids can be characterized by a single coefficient of viscosity for a specific temperature. Although this viscosity will change with temperature, it does not change with the flow rate or strain rate. Example: Water.

### Thixotropy

The property of certain gels or fluids that are thick (viscous) under normal conditions, but flow (become thin, less viscous) over time when shaken, agitated, or otherwise stressed. They then take a fixed time to return to a more viscous state.

It exists if the viscosity of a substance being under shear forces decreases by time, but recovers to the original value after a certain non-shearing period.

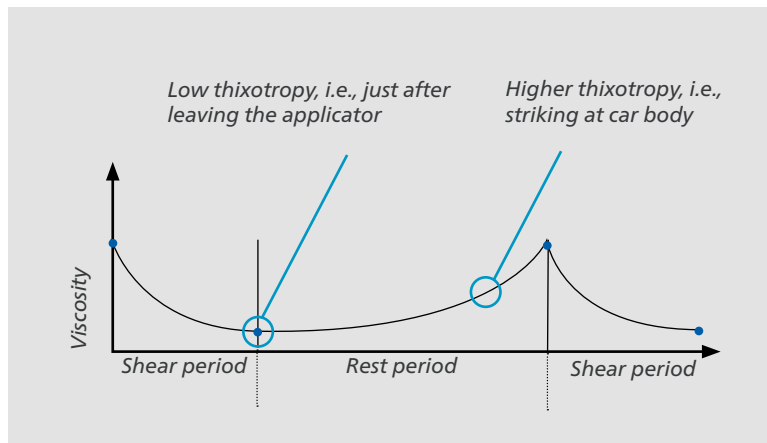

Thixotropy in viscosity/time diagram.

## Rheometers – measuring viscosity

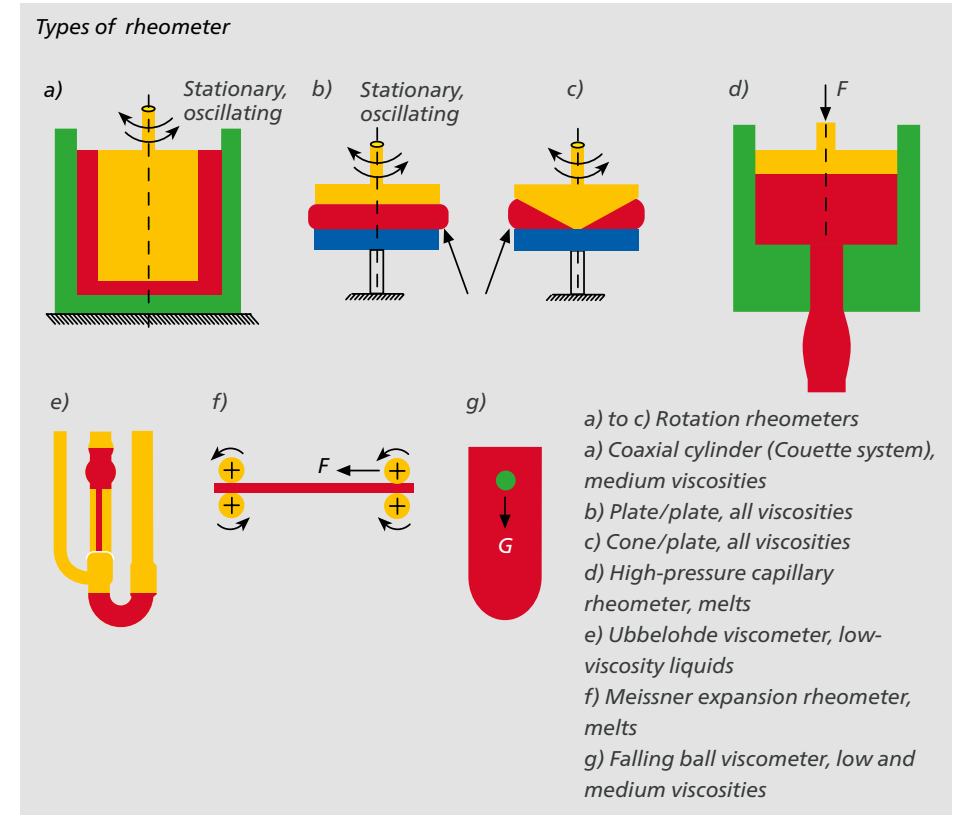

### Differences between viscometers and rheometers

Viscometers, in comparison to rheometers, are usually relatively simple instruments. Their simplicity of design and operation can offer advantages in terms of ease of use. Most viscometers operate by rotating a spindle in one direction in the sample. Viscosity is determined by measuring resistance to this rotational force.

Rheometers can apply oscillatory and rapid step changes in stress and strain, and can therefore determine viscoelastic properties (providing information on the structural properties of the sample) as well as flow properties.

### Units for viscosity

$t = \eta D$   
 $1 \text{ Pas} = 1 \text{ Ns/m}^2 = 1 \text{ kg/ms}$   
 $1 \text{ mPas} = 0.001 \text{ Ns/m}^2$   
 $1 \text{ mPas} = 0.01 \text{ Poise (P)}$   
 $1 \text{ Poise} = 0.1 \text{ Pas}$

## Wetting

Wetting is the ability of a liquid to maintain contact with a solid surface, resulting from intermolecular interactions when the two are brought together. The degree of wetting (wettability) is determined by a force balance between adhesive and cohesive forces. Wetting deals with the three phases of materials: gas, liquid and solid.

### Wetting achieved with different viscosities



Minimal wetting with sag-resistant materials

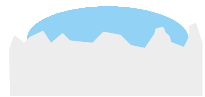

Ideal wetting with highly liquid materials



No wetting (theory)



Minimal wetting with sag-resistant materials



Slight wetting with pasty materials



Good wetting with viscous materials



Ideal wetting with highly liquid materials

Wetting of the substrate when using pasty adhesives/sealants

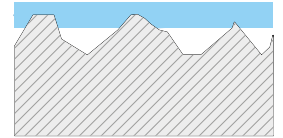

Wetting of the substrate when using liquid adhesives/sealants

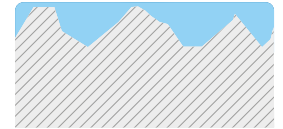

## “Water drop” test

### For this reason:

Cleaning, grinding, fine-grain blasting, pickling/caustic treatment...



### Optimal Wetting:

Provides optimum conditions for all types of adhesives whilst making optimum use of their properties

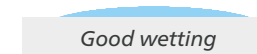



# 5. The adhesive joint and its tension distribution

## Cross-section of an adhesive bond

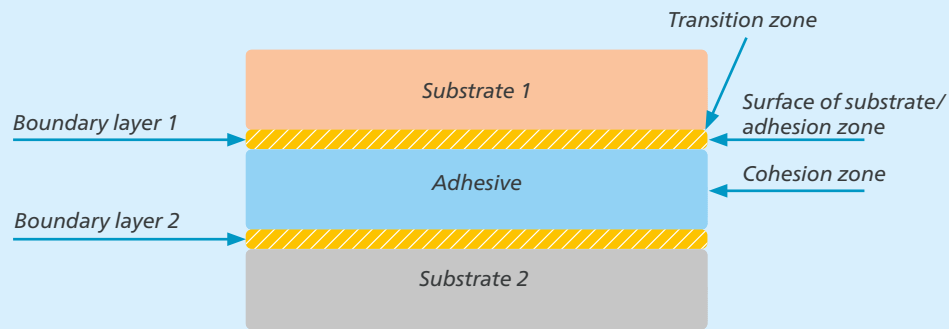

The boundary layer refers to a thin layer corresponding to the interfaces between the substrate and the adhesive where all the molecular forces, called "Van der Waals forces", are.

## Distribution of tension

### Bonding:

- Uniform tension distribution
- Force distribution over the entire surface



### Riveting and Fastening:

- Non-uniform tension distribution
- Spot force transmission

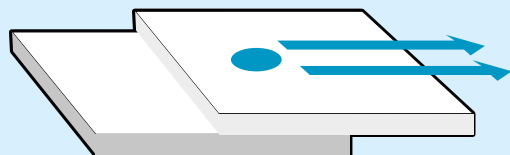

## On the strength of riveted joints

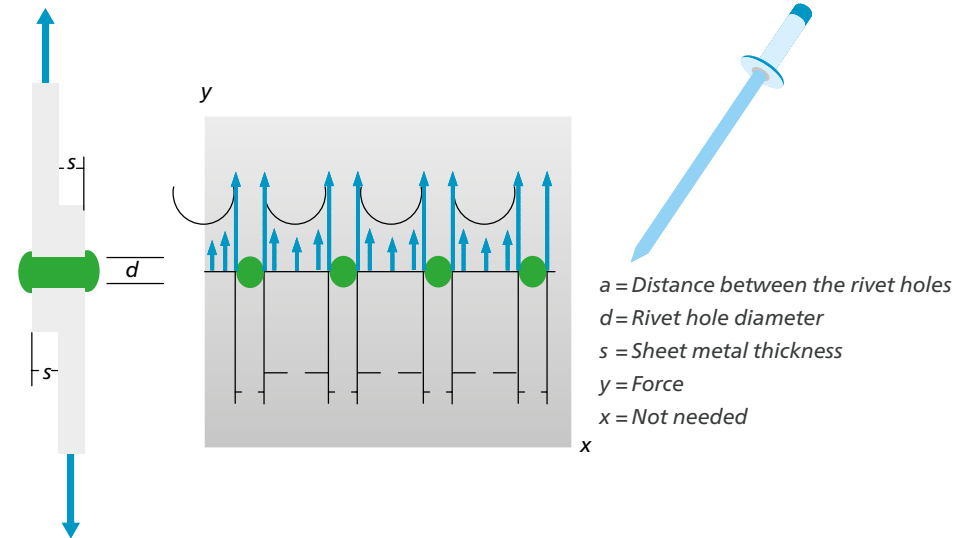

When exposed to tensile load, tension peaks arise at the drilled and counter bored rivet holes. The extent of these tensions is independent of the rivet hole diameter.

## On the strength of bonded joints

### i.e Beveled overlaps

When exposed to tensile load, tensions are uniformly distributed. In addition, neither warping nor scaling will occur with bonding.

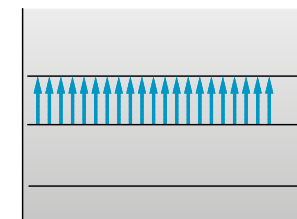

- $l$  = Bonded joint
- $l$  = Length of the beveled part
- $s$  = Sheet metal thickness

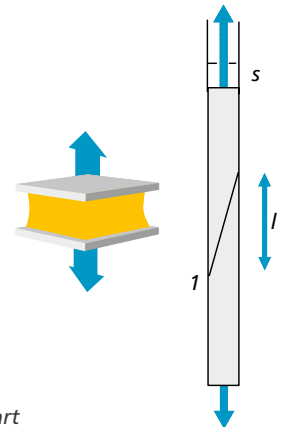

## 6. Advantages/ disadvantages of bonding

### Some advantages of bonding

#### Different kinds of material can be joined

- Metals of the same or different kind and plastics.
- At the same time the adhesive prevents contact corrosion.
- Compensates tensions between the components.
- Seals at the same time.

#### No thermal changes in the material structure

- As with welding, soldering.

#### No costly treatment of the visible surfaces is required afterwards

- Polishing of the visible surfaces as with welding, etc., is not necessary.

#### Bonding permits extremely lightweight construction

- Thinner metal sheets than with riveting.

### Disadvantages of bonding

#### The final strength is not achieved immediately

- As compared to fastening, riveting, soldering and welding.
- You have to wait for the reaction time.

#### In most cases, the bond cannot be detached without damaging the mating parts\* unlike screwing or riveting

- Bonds can only be used in a limited temperature range.
- Bonds are sensitive to peel and split forces (uneven loads).

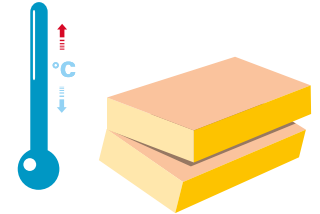

\* There are exceptions. Such as in the case of hot melt adhesives or water-based acrylates where the part can be reheated and detached.

# 7. Benefits of bonding

## The Big 4 – main benefits

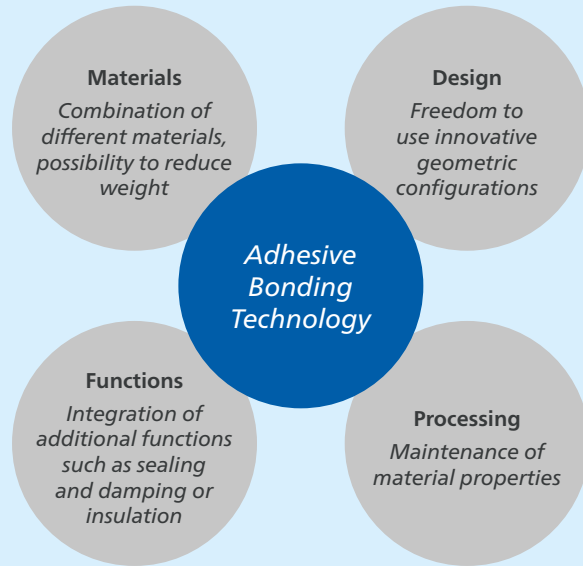

### Bonding in comparison

Joining technique	Multi material design	Body stiffening	Crash stability	Engineering strength	Corrosion resistance	Acoustics	Speed of production	Initial strength
Bonding (structural)	√√√	√√√	√√√	√√√	√√	√√√	√√√	X
Spot welding	X	○	○	○	X	X	X	√√√
Clinching (press joining)	X	○	X	√	○	X	X	√√√
Riveting	○	○	X	√	X	X	X	√√√
Screwing / bolting	○	○	○	○	X	X	X	√√√
Laser welding	X	√√	√√	√√	○	○	○	√√√
Laser stitching	X	√	○	○	X	X	√√	√√√

√√√ excellent √√ very good √ good ○ average X bad

### Bonding in comparison

Application criteria	Cost factors	Bolts/screws	Rivets	Welding	Spot welding	Clinching	Clip fastening	Bonding (Structural)	Bonding (Elastic)
Joining together dissimilar materials	Optimum choice/ most economical use of materials	√√	○	-	√	√√	√√	√√	√√
Calculability of joint, dependability of joint strength on temperate, creep under statistic load	Development costs, the need to take account of specific work process and design requirements associated with the fastening technique	√√	√√	√√	√√	√	○	√/○	√√
Thermal distortion	Additional processing stages	√√	√	-	-	√	√√	√√	√√
Occupational physiology (noise, chemical emissions)	Loss of man-hours as a result of illness	√	○	○	○	○	√√	√/	√/○
Sealing of joint	Additional work and expense in sealing joint	-	-	√	○	○	○	√√√	√√
Susceptibility to corrosion	Preventive measures to guard against crack corrosion and galvanic corrosion	○	-	√	○	√	○	√	√
Waiting time between joint assembly and adequate strength attainment	Integration in the production cycle	√√	√√	√√	√√	√√	√√	√/○	√/○
Temperature-resistance of joint	Need to take account of extreme exposure conditions	√√	√√	√√	√√	√√	√/○	√	√/○
Ease of disassembly	Ease of repair/ effect on recycling costs	√√	√	○	○	√	√	○	√

√√ very suitable √ suitable ○ partly suitable - unsuitable

# 8. Structural bonding, elastic bonding and sealants

## Bonding, sealing and insulation

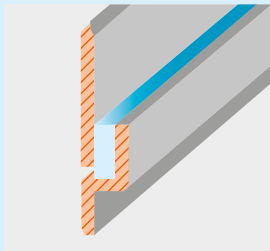

1. Bonding according to DIN 16920, is a process designed to join two materials of similar or different characteristics, with an adhesive substance. An adhesive is thus a non-metallic substance capable of producing a joint based by means of surface bonding (adhesion) and inner bonding (cohesion).

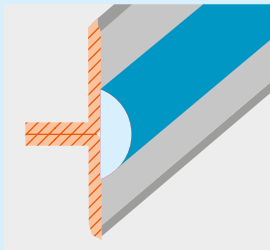

2. Sealing according to DIN 52460, is a method for closing peripheral areas. A technical seal should reliably close off areas of division brought about as a result of manufacturing or assembly in components against penetration or escaping of media, i.e., gases or liquids, to avoid leakages.

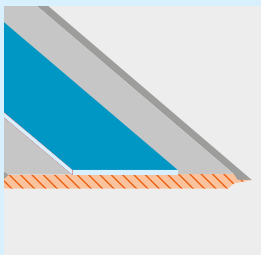

3. Insulating is a method of dispensing material that prevents or reduces the passage, transfer, or leakage of heat, electricity, or sound. This application is very common when sound dampening is a requirement.

## Insulating effect against contact corrosion

Example of insulation

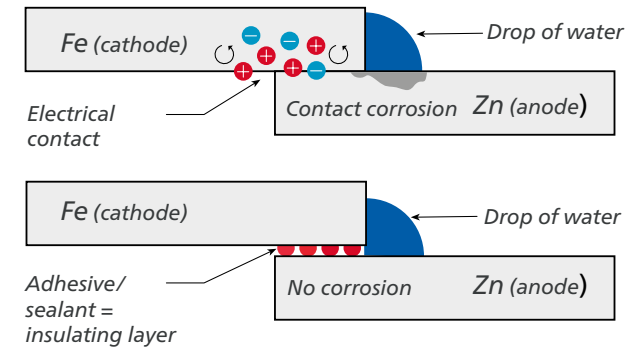

### Structural bonding

- High force transmission  
10 - 30 N/mm<sup>2</sup> TSS
- Low elongation at break  
0 - 70%
- Small gap (approx. 1 mm)

### Elastic bonding

- Medium force transmission  
1 - 10 N/mm<sup>2</sup> TSS
- Medium elongation at break  
70 - 300%
- Medium gap

### Sealing and insulating

- Low force transmission
- High elongation at break  
300 - 700%
- Large gap

## Structural bonding, elastic bonding, sealing and insulating

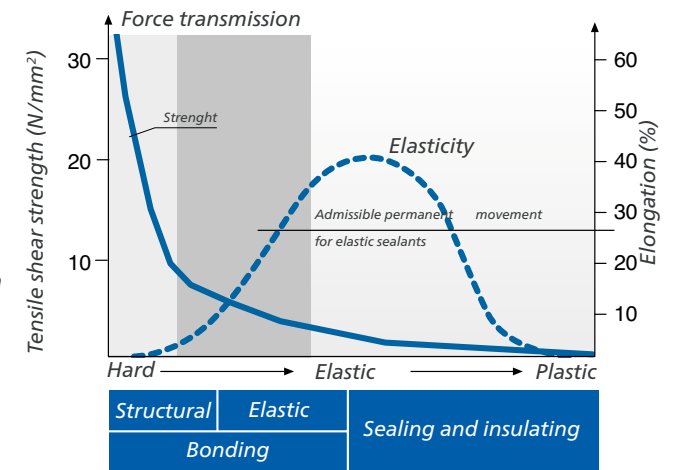

Basic rule:  
Higher strengths are the result of thinner adhesive layers!

Exception:  
Elastic bonding.

# 9. Influences on the bonding function

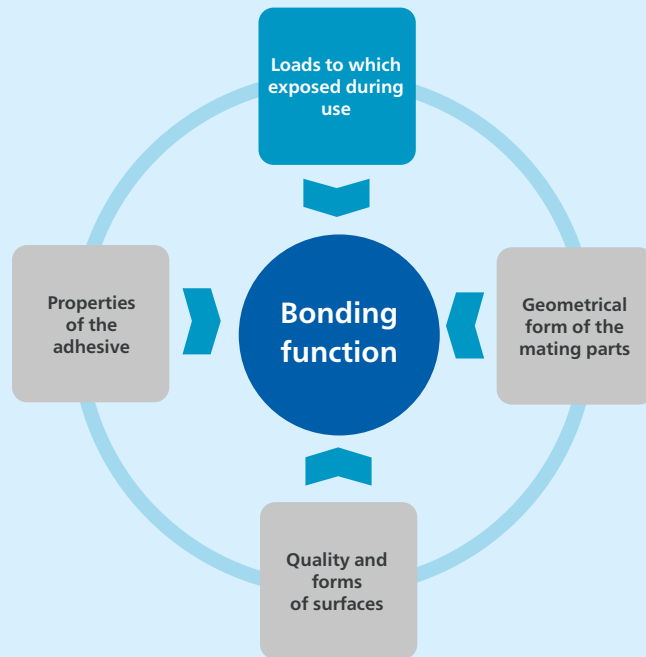

## How does an adhesive act?

- It wets the surface and adhesive forces become effective.
- It gets locked to the surface.
- It solidifies. (cures, sets...)
- It transmits forces = structural adhesive.
- It absorbs forces = elastic adhesive.

## Loads to which adhesives are exposed during use

### Mechanical stresses

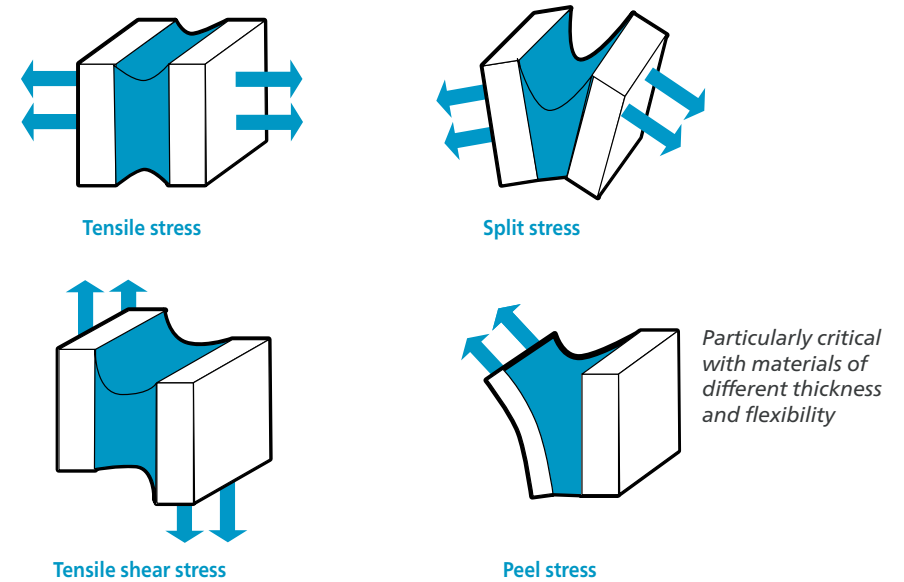

### Mechanical stresses to which adhesives are exposed

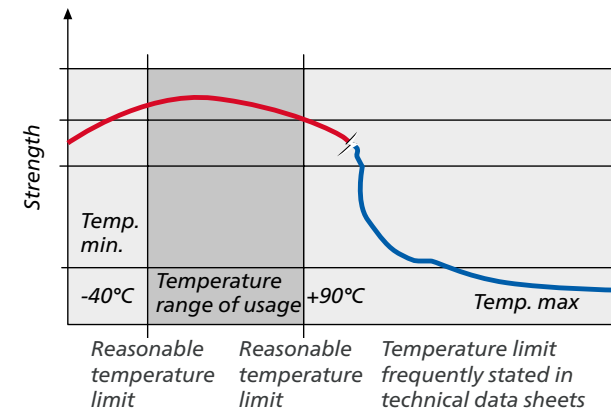

## Loads to which adhesives are exposed during use

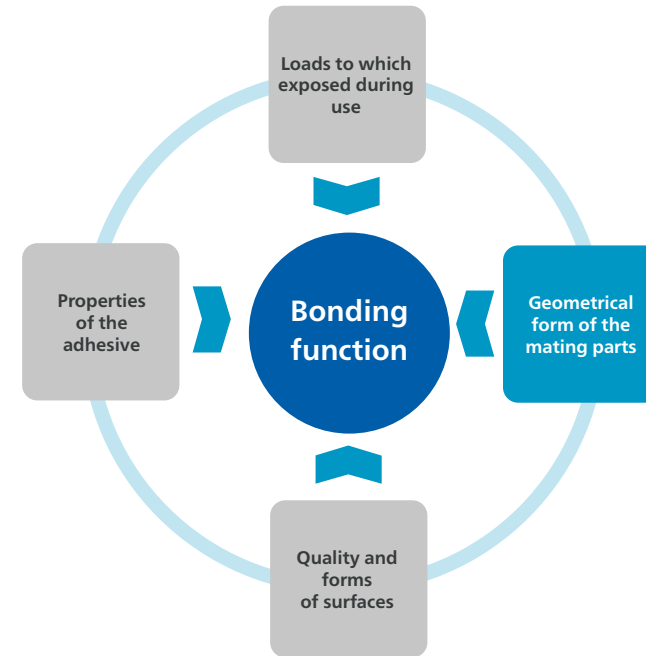
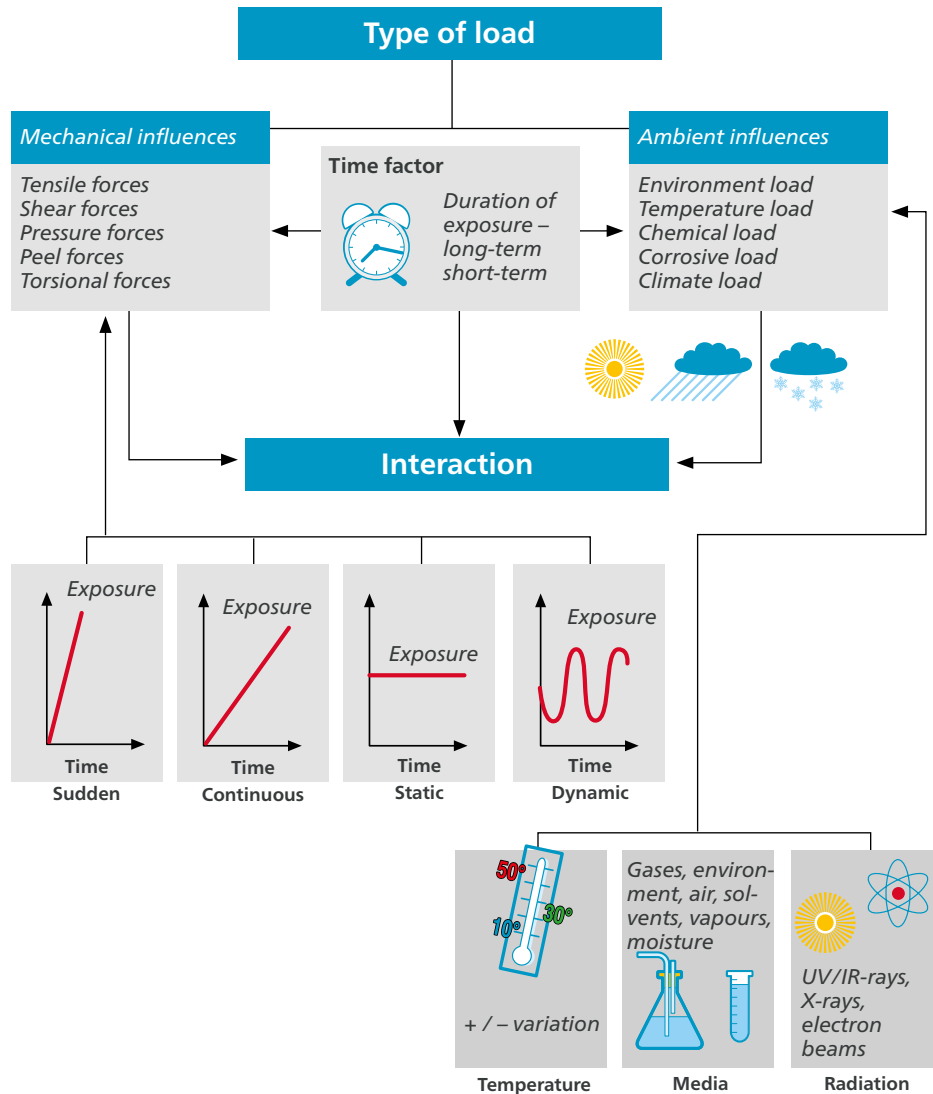

## Geometrical form of the mating parts

Unfavorable design and corrective design solutions

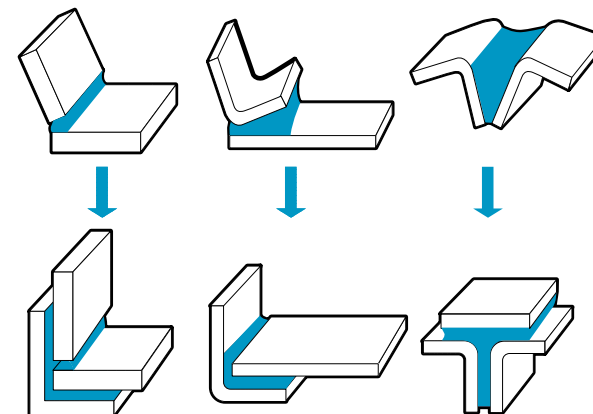

## Design of bonds exposed to peel forces

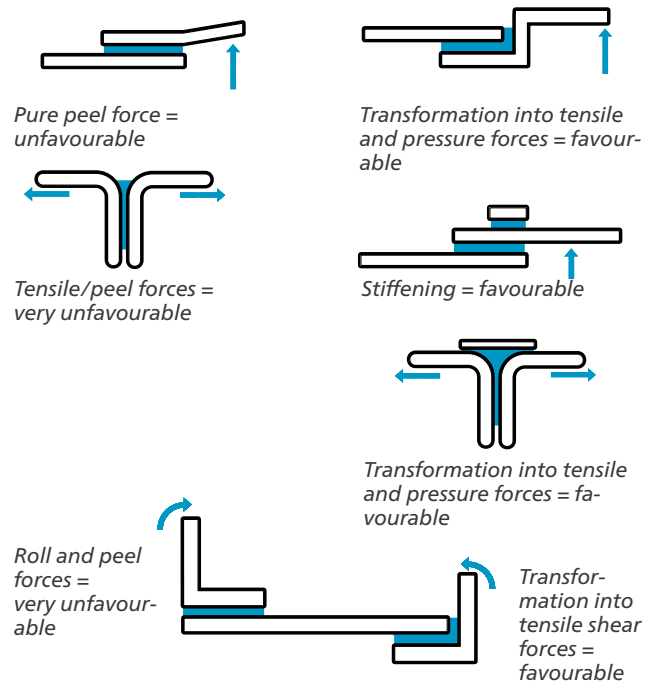

## Design of bonds exposed to tensile shear forces

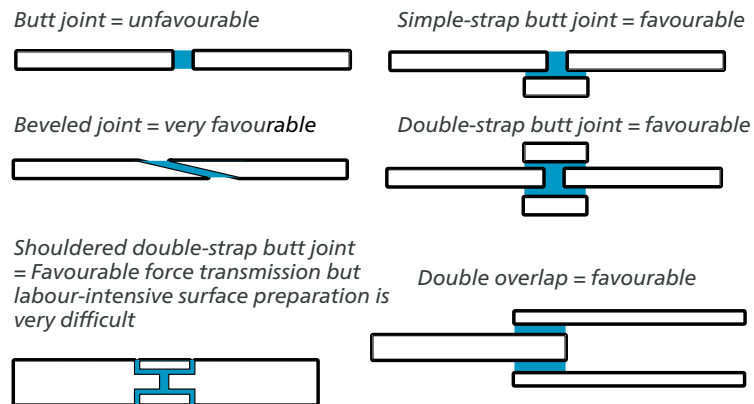

## 1. New Design: Welding → Bonding

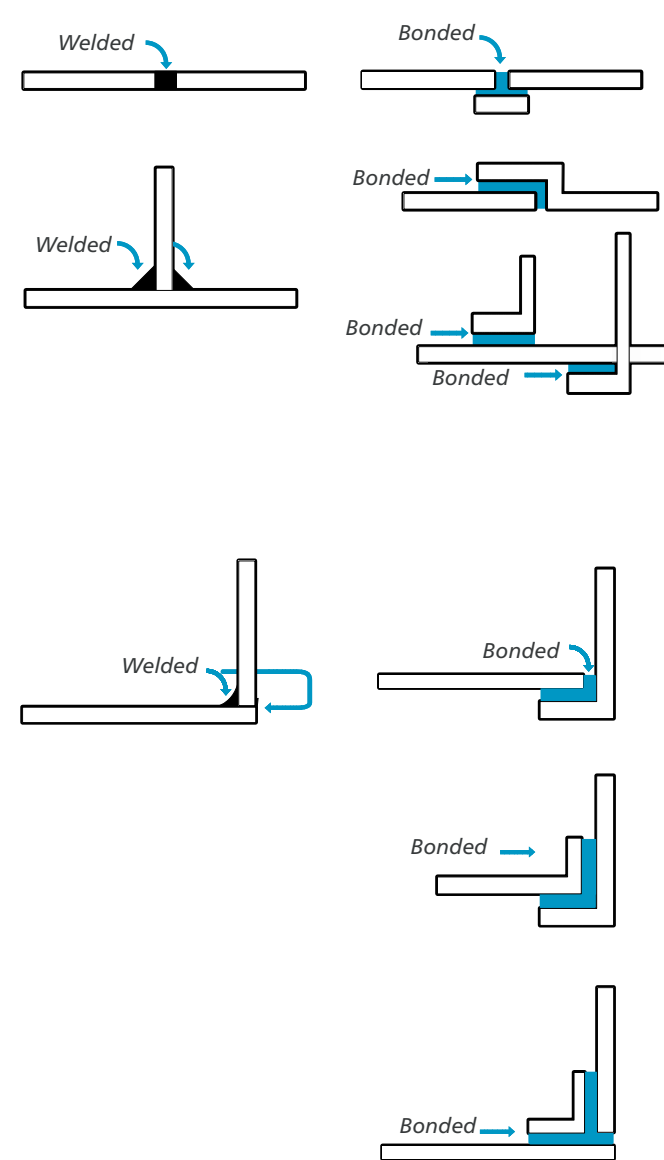

## How to determine the characteristics of the bonding surfaces

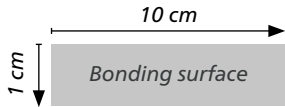

The bonding surfaces should be as large as possible to ensure reliable force transmission!

- It is possible to achieve high levels of strength using a spot-bonding technique with a high-strength adhesive, but basically bonding is a means of connecting via surface areas.
- The adhesive film transmits the acting forces as with bonds realized by means of screws or rivets.
- Owing to the fact that, in contrast to fastening or riveting, bonding provides a bond closed in itself, one achieves a uniform distribution of tension over the entire surface.

## Example

**Example**

10 cm

1 cm

*Bonding surface*

*Calculation (example):*  
 $10\text{ mm} \times 100\text{ mm} = 1\,000\text{ mm}^2$

*Bonded using elastic MS-Polymer (3.0 MPa)*  
 $1\,000\text{ mm}^2 \times 3\text{ N/mm}^2 = 3\,000\text{ N} = 300\text{ kg}$   
 The stress-to-rupture of this bonding surface is 300 kg

*Bonded using 2 part Epoxy (30 MPa)*  
 $1\,000\text{ mm}^2 \times 30\text{ N/mm}^2 = 30\,000\text{ N} = 3\,000\text{ kg}$   
 The stress-to-rupture of this bonding surface is 300 kg

## Cohesion and adhesion failure

An adhesive can only fulfil its job if the adhesive and cohesive forces are approximately as great as the inherent strength of the mating parts to be bonded.

**Too little adhesion** The bond breaks at the boundary surface.

**Too little cohesion** The inherent strength of the adhesive is not sufficient - when detaching, areas remain covered in adhesive.

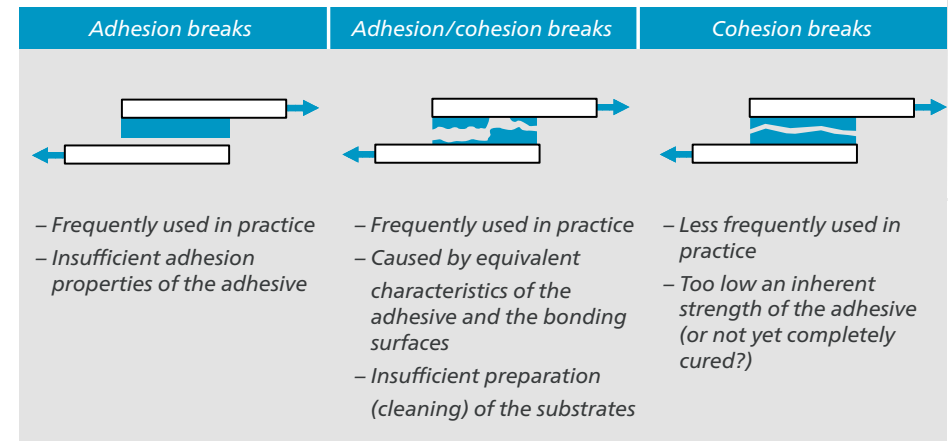

## Important criteria for adhesive applications

- The adhesive should be thin fluid (low viscosity) for wetting the surface.
- Energy of the stream when hitting the surface should be relatively high.
- Specific differences need to be considered for different applications.

High viscosity adhesive

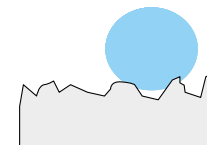

Substrate

Low viscosity adhesive

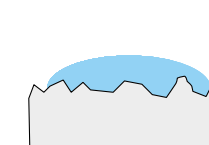

Substrate

A real multi-purpose adhesive, i.e., an adhesive which bonds all materials and, if possible, under a variety of conditions does NOT exist!



# 10. Importance of surface treatment

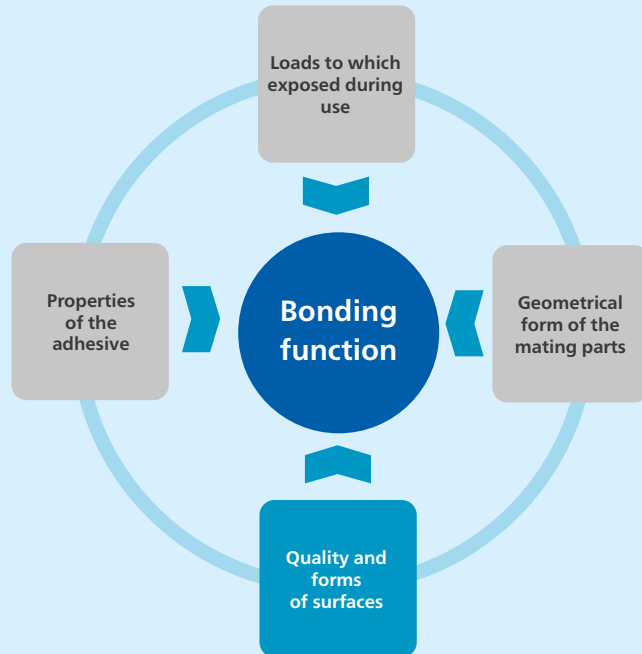

## Quality and forms of surfaces

### Substrate requirements

- **Load-bearing capacity**
  - The substrates must be able to bear loads, i.e., be firm!
- **Cleanliness**
  - The substrates must be clean!
  - Free from grease, oil, dust, moisture...dirt!
  - Cleaner and adhesive must be compatible
- **Adhesiveness**
  - Advanced adhesives have a wide range of adhesion and, in most cases, adhere to the substrates without the use of primers (coatings).
  - Primers should be used where required – particularly for structural bonds.

### Surface preparation

Cleaning, degreasing, passivation

### Surface pretreatment

Mechanical, chemical and physical techniques

### Surface post-treatment

Acclimatization, primers, adhesion promoters, activators

## Surface preparation and pre-treatment methods

Surface treatment		
Cleaning/degreasing	Mechanical methods	Chemical/physical methods
Removal of loose layers of rust, oxides, weathering and paint residues	Different kinds of hard brush and polishing brush methods (following degreasing in advance)	Pickling of aluminum, hardened and stainless steels as well as hard metals
Reinforcing of the substrates in the case of absorbent or crumbling surfaces	Application of sanding belts and grinding discs. Abrasive paper etc. (K120-180) following degreasing in advance	Caustic treatment of plastics which are difficult to bond such as PTFE, POM or PP
Removal of undesirable layers by using degreasing detergent	All kinds of blast methods (dry or wet blast) using sharp-edged, fine grains	Low-pressure plasma treatment of plastics which are difficult to bond, such as PE, PA, PP or others with a problematic surface layer

## What is a primer?

Primers are liquids applied prior to the application of the adhesive in order to:

- Increase the bonding quality, thus achieving a better adhesion of the adhesive point.
- Act as a barrier at open-pored substrates.

## Why use primers?

Permanently adhering almost anything to a porous substrate can be a nightmare at times. The problem is that, because the substrate is porous, it will absorb the adhesive and shorten the durability.

The solution to this problem, and problems like it, is to use an adhesive primer.

## Why must the substrate be clean?

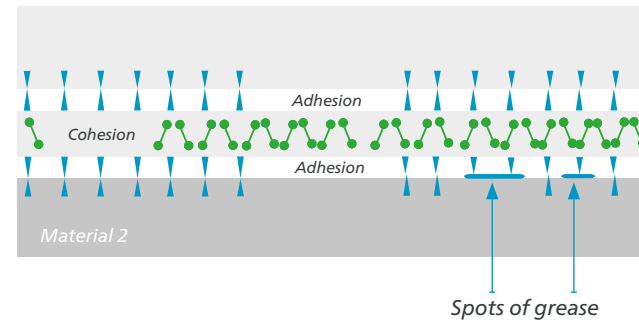

- Dirt on the substrates prevents the adhesive from building up adhesion bridges.
- The adhesive adheres well to the dirt but not to the material's surface.

## Different surface characteristics

- **Geometric surface**  
(2-dimensional measurements)
- **Real surface**  
(3-dimensional measurements)
- **Effective surface**  
(wetted surface)

## Smooth and rough surfaces

- **Extremely smooth – polished – surface**  
Glass/moisture/glass
- **Normal surface**  
No approach of the molecules

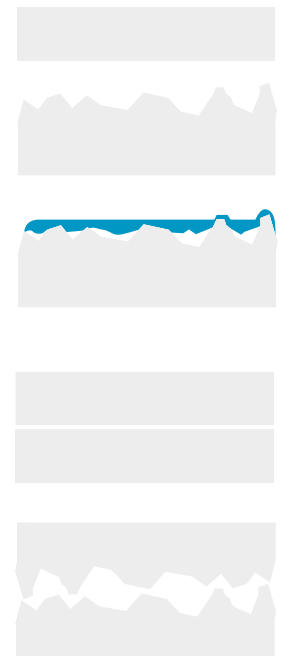

# 11. Surface energy

## Definition:

- The sum of all intermolecular forces that are on the surface of a material; the degree of attraction or repulsion force that a material surface exerts on another material.
- In the case of liquids this same definition is applied to define the surface tension – as a result of this surface tension, liquid with low surface tension tends to contract and form droplets.
- Surface tension can be defined as the resistance of a fluid to deform or break. Such resistance is defined directly by the intermolecular forces that are on the liquid surface.

## Influences of surface energy on the adhesive force

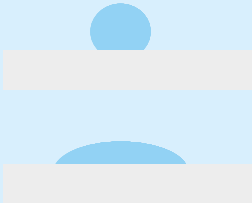

- **Low-surface-energy substrate**  
Rubber, polyolefines (PE, PP, ...), silicone, silicone-containing paints and coatings, teflon...
- **High-surface-energy substrate**  
ABS, acrylic glass, aluminum, bronze, iron, glass, rigid PVC, copper, brass, steel, zinc.

High surface energy = good adhesion results		Low surface energy = poor adhesion results	
<b>ABS</b>	Acrylonitrile-butadiene-styrene	<b>EPDM</b>	Ethylenepropylene terpolymer
<b>BS</b>	Butadiene-styrene	<b>EVA</b>	Ethylenevinyl acetate
<b>CA</b>	Cellulose acetate	<b>FPM</b>	Fluoric elastomers
<b>CFK</b>	Carbon fibre reinforced plastic	<b>HDPE</b>	High-density polyethylene
<b>EP</b>	Epoxy	<b>LDPE</b>	Low-density polyethylene
<b>GFK</b>	Glass fibre reinforced plastic	<b>NBR</b>	Nitrile rubber
<b>PA</b>	Polyamide	<b>NK/NR</b>	Natural rubber
<b>PC</b>	Polycarbonate	<b>PE</b>	Polyethylene
<b>PI</b>	Polyimide	<b>PETP</b>	Polyethylene terephthalate
<b>PMMA</b>	Polymethylmethacrylate	<b>PO</b>	Polyolefine
<b>PPO</b>	Polyphenylene oxide	<b>POM</b>	Polyoxymethylene
<b>PSU</b>	Polysulfone	<b>PP</b>	Polypropylene
<b>PUR</b>	Polyurethane	<b>PS</b>	Polystyrene
<b>PVC</b>	Polyvinyl chloride	<b>PTFE</b>	Polytetrafluoroethylene
<b>SBR</b>	Styrene-butadiene rubber	<b>SI</b>	Silicone

# 12. Properties of adhesives

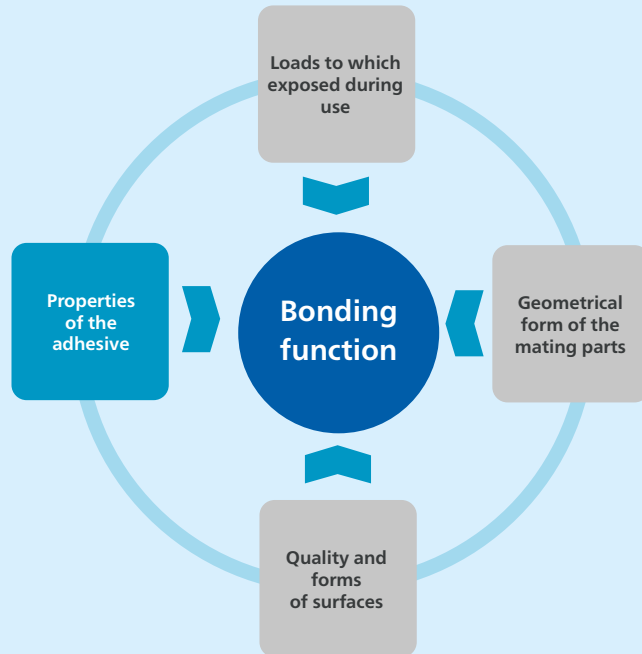

## Classification of adhesives on a chemical basis

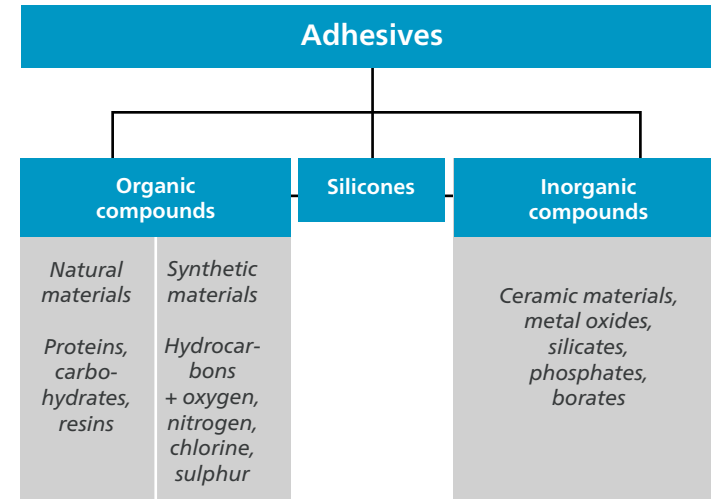

### Classification of organic adhesives and silicones according to the bonding mechanism

Physically hardening adhesives	Chemically curing adhesives
Hotmelts	<b>Polymerization adhesives:</b> Superglues Methyl methacrylates (MMA) Unsaturated polyesters Anaerobically curing adhesives Radiation curing adhesives
Wet solvent-containing adhesives	
Contact adhesives	
Dispersion adhesives	<b>Polycondensation adhesives:</b> Phenolic resins Silicones Polyimides Bismaleinimides MS-polymers
Water-based adhesives	
Pressure sensitive adhesives	
Plastisols	
	<b>Polyaddition adhesives:</b> Epoxy resins Polyurethanes

# Properties of adhesives

## Typical portfolio of industrial adhesives

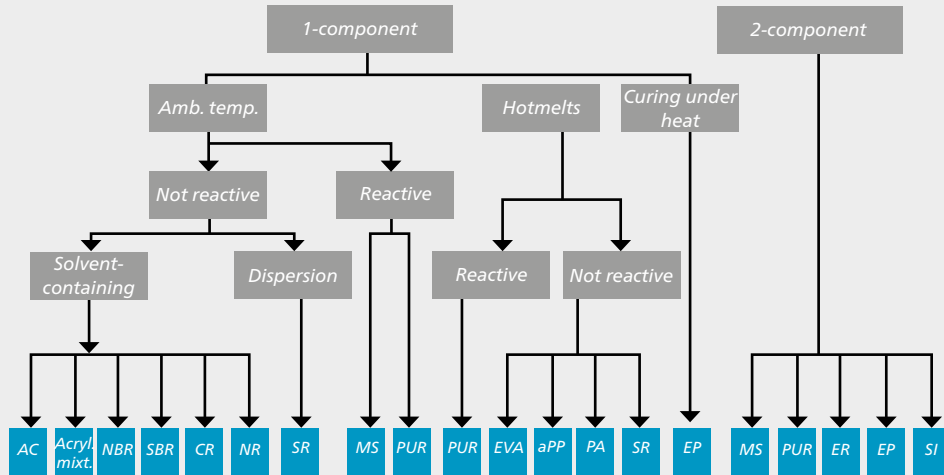

The addition of various ingredients affects the properties of the adhesive in different ways:

**Chalk** helps the **oil absorption** and **glass beads** are in the later joining process (folding) for a defined minimal distance so that a certain minimum thickness of the adhesive can be guaranteed in the fold.

**Color** pigments are there to help the **"visibility"** of the adhesive on the metal sheet by a vision system.

### Adhesive application – "bead" application vs. surface application

- A bead-style adhesive application is recommended, especially with pasty adhesives.

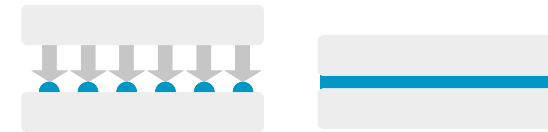

### Ingredients

- Carbon black
- Cotton fibers
- Glass beads
- Silica sand
- Chalk
- Urea
- Paint pigments
- Stabilizer
- ...

- **NOTE:**
  - Application should be as even as possible
  - Bead diameter and distance coordinated with the bonding joint
  - Mating parts bonded with adhesives which crosslink under the influence of moisture must be joined before the adhesive has formed a skin
  - Keep pressure as even as possible
  - Do not reduce the bonded joint to "zero", use spacers if necessary

## Properties of adhesives

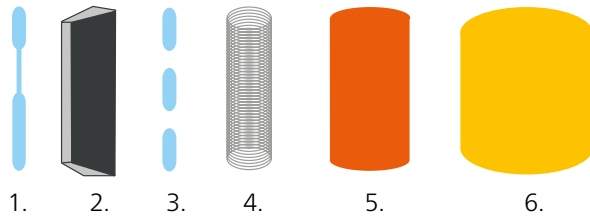

### Application technologies

1. Round bead application
2. Shaped bead application
3. Stitch bead application
4. Swirl application
5. Flat stream application
6. Airless application

### Glossary

<b>Setting</b>	Curing of the adhesive by means of chemical/physical processes	<b>PSA Pressure-Sensitive Adhesive</b>	Low-cohesion adhesive, adheres when exposed to low pressure
<b>Setting time</b>	Period of time during which the bonded joint reaches its final strength	<b>Hardening time</b>	Period of time during which the bonded joint reaches its final strength
<b>Evaporation time</b>	Period of time required for the evaporation of solvent or water	<b>Resin</b>	A component which effects adhesion by means of a chemical reaction
<b>Adhesion</b>	Bond between the mating parts and the adhesive layer	<b>Bonding joint</b>	Space between two bonding surfaces, filled with adhesive
<b>Curing</b>	See "Setting"	<b>Cohesion</b>	Molecular bond within the adhesive layer
<b>Dispersion</b>	Solid polymer particles stably dispersed in water	<b>Reaction adhesive</b>	Adhesive setting/ crosslinking by means of a chemical reaction
<b>Final strength</b>	Max. load-bearing capacity following complete curing	<b>Hotmelt adhesive</b>	Solid and solvent-free adhesive, liquefying under the influence of heat and solidifying when cooled down
<b>Final strength</b>	Body (to be) bonded together with another body		

## Other Pocket Guides in this series

### Hem flange bonding

The hem flange describes a mechanical joint design which is used for joining inner and outer closure panels, as in metal doors, hoods, bonnets or liftgates. Those parts need a high degree of quality and require an optimal adhesive application. Therefore hem flange bonding is one of the most challenging process steps in the Body in White production process.

The pocket guide on hem flange bonding gives comprehensive information on how to hem and bond a flange, the challenges and the various layouts of the process.



Ordering number 9833 2150 01

### Dispensing Technique

Many industries now use adhesive bonding on a large scale for their assembly operations. Techniques available for metering and dispensing the adhesives include manual applicators, automated application units (robots), and special systems for pumping adhesive material with low or high viscosity. The method of application is selected according to adhesive type and the demands of the assembly operation.

The SCA pocket guide on dispensing technique explains and compares the different techniques and discusses their areas of application.



Ordering number 9833 2169 01



Atlas Copco  
Industrial Assembly Solutions  
SCA Dispensing  
[joining.atlascopco.com](http://joining.atlascopco.com)

