

# Smart Connected Assembly - from Vision to Reality

How Industry 4.0 will drive an evolution  
of the Assembly processes

Atlas Copco

Smart connected assembly is not only a vision - it is available in 2016 enabling higher quality and higher efficiency

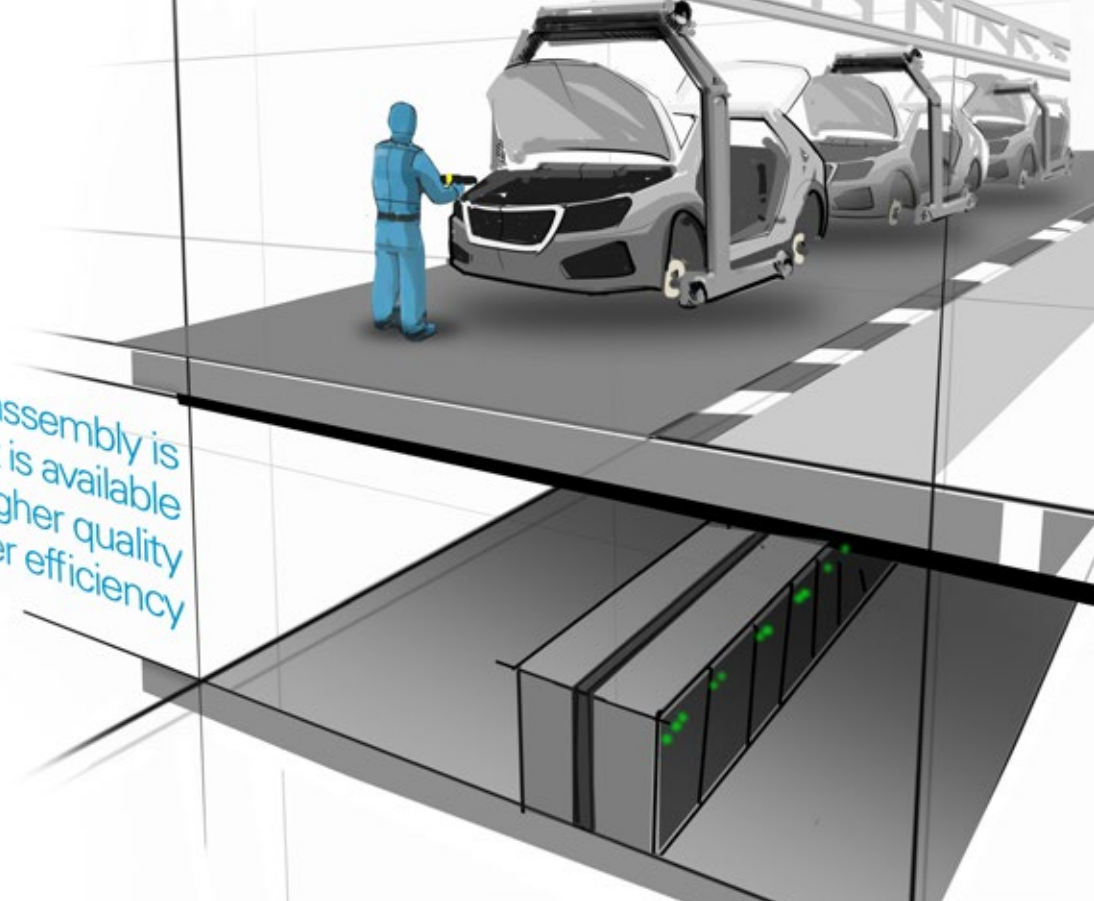

## 1. The digitalization of manufacturing

### 1.1. Drivers for the fourth industrial revolution

#### 1.4.0 stands for the fourth industrial revolution

1.0 was the introduction of mechanization of manual work and steam engines in the second half of the 18th century

2.0 was the electrification and introduction of division of labour in 1870 and onwards

3.0 was the introduction of computers and automation of the production processes in the 1970s

4.0 is the cyber and physical systems merging. The real and virtual worlds are merge in production

The fourth industrial revolution — or the digitalization of manufacturing and assembly — has arrived.

A key enabler is the emergence and use of new technologies for connecting people, equipment and machines. And with it, the improved capacity for integrated analysis and use of large amounts of data across value chains. Another is the development and adoption of Industry 4.0 in industrial environments as a critical element of smarter and more automated manufacturing and assembly. Manufacturing companies have been implementing sensors and computerized automation for decades. But seamless connectivity and communication have been missing for establishing a fully connected production network, in which information carriers communicate with each other and exchange data and information in near real time. And this is true for both machine-to-machine, and machine-to enterprise systems. The data and information can be used to improve productivity and quality, but also offer opportunities to introduce new or enhanced services to customers.

The term "Industry 4.0" originates from a project in the high-tech strategy of the German government. It was introduced in 2011 at the Hannover fair<sup>1</sup>. In October 2012, the Working Group on Industry 4.0 presented a set of Industry 4.0 implementation recommendations to the German federal government which promotes the computerization of manufacturing. Today there are similar

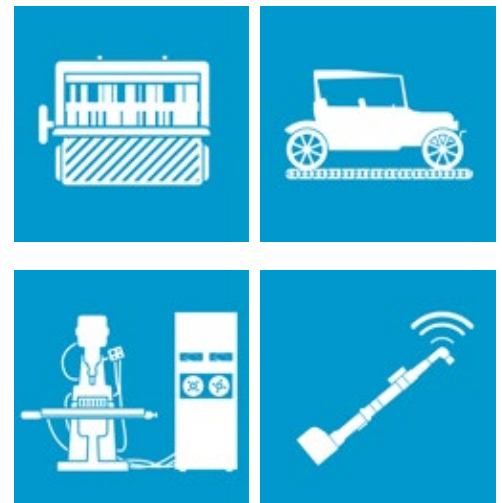

government and industry driven initiatives in USA, Asia and other European countries, known as Industrial Internet Consortium, Made in China 2025, and Make in India to name a few.

In a global economy, where most Western companies have difficulties in competing on labour cost, they need to seek productivity gains and competitive advantage. Mainly through new innovations and the use of technologies for providing high-end quality service or product with the least cost.

## 1.2 Why is it a revolution

Is Industry 4.0 really a revolution or is it just a “marketing hype” promoted by the software industry and management consulting firms? In a global economy, where most Western companies have difficulties in competing on labour cost, they need to seek productivity gains and competitive advantage. Mainly through new innovations and the use of technologies for providing high-end quality service or products with the least cost. Connectivity and smart communication between machines, humans and assembly components will increase productivity and quality dramatically and elevate mass customization to new levels.

Various industry and research reports indicate a tremendous potential in the transformation of industrial production:

- By 2020, European industrial companies will invest EUR 140 billion annually in Industry 4.0 application<sup>2</sup>
- In five years, more than 80% of companies will have digitalized their value chain<sup>3</sup>
- By 2018 6 billion connected things will require support<sup>4</sup>
- Productivity gains up to 30% aided by Industry 4.0 technologies

## 1.3 Vision of Industry 4.0 manufacturing and assembly plant

The vision of future manufacturing is autonomous factories and production processes where workers only are needed to overlook the process and to intervene if any corrections are required. Materials, products and equipment will communicate with each other and drive the production process by exchanging information and instructions in real time. One scenario is to start with an initial work piece that knows what operations

and materials it requires in each step in order to prepare, build and assemble the final product. As machines and products communicate, flexible routing and optimized utilization of resources will be automatic. The connected systems go beyond the factory and communicate with all parts of the value chain from product development to after sales and service. It will also be extended to external partners.

## 1.4 Opportunities

The expectations on future manufacturing are high - and for good reasons. Productivity improvements can be gained from information sharing in real time, and resources can be utilized more efficiently by dynamic allocation. The product quality will improve from highly controlled production processes with automatic monitoring and quality assurance.

In addition, all connected smart products and machines generate huge amounts of data that will be captured. And by analyzing this data new insights will be possible. For example, innovation and new product development will be facilitated faster by integrated analysis of usage data, service data and production data. Time to introduce new products in production will be shorter – and rebalancing of a production line will be easier.

Future new services enabled by smart connected devices and equipment will emerge. Especially services based on big data analytics

together with expert knowledge of an area are fundamental in many of the ideas of new value added services that are being developed. Predictive maintenance is a good example of when new data provides information that can be turned into intelligence, making it possible to perform maintenance more efficiently. If data from multiple customers are joined, even better intelligence can be drawn and higher value added. Service providers or equipment manufacturers are well suited to develop such services based on data from many customers. Maintenance is one area where this is applicable and we can expect to see new commercial and delivery models.

Many opportunities will be implemented incrementally and the full effect of Industry 4.0 is expected to take 15 to 20 years before being realized.

## 1.5 Challenges to overcome

There are numerous challenges that companies, policy makers and industrial associations need to overcome, to unlock the full potential of Industry 4.0.

In a smart, connected landscape, companies face new strategic decisions; e.g. whom to partner and collaborate with to offer customers seamless value solutions, how to foster an innovative culture required to develop a long-term digital capability, and how to adapt and develop new services to remain competitive?

The development of an innovative digital culture goes beyond Research & Development as producers must focus to upgrade their workforce's skills. Industry 4.0 will drive significant changes in how industrial workers perform their jobs, and new types of jobs will be created while others become obsolete. The number of physically demanding or routine jobs will decrease, while the number of jobs requiring flexibility, analytics and programming skills will increase. As the digital and physical worlds are

growing closer together, new requirements on ergonomic adjustments to production plant and safety standards are arising.

In addition, companies are dependent on policy makers and industrial associations to agree on technology standards and rules for data security and data protection. All which have an impact on companies' decisions on if they should pursue an open or closed system, how much functionality and data they should put in the cloud, and how they should manage ownership and access rights to product data?

There are no simple answers to these challenges. But regardless of which Industry 4.0 strategy a company chooses, they need to take action now and start preparing for a transition if they are to remain competitive and relevant for their customers.

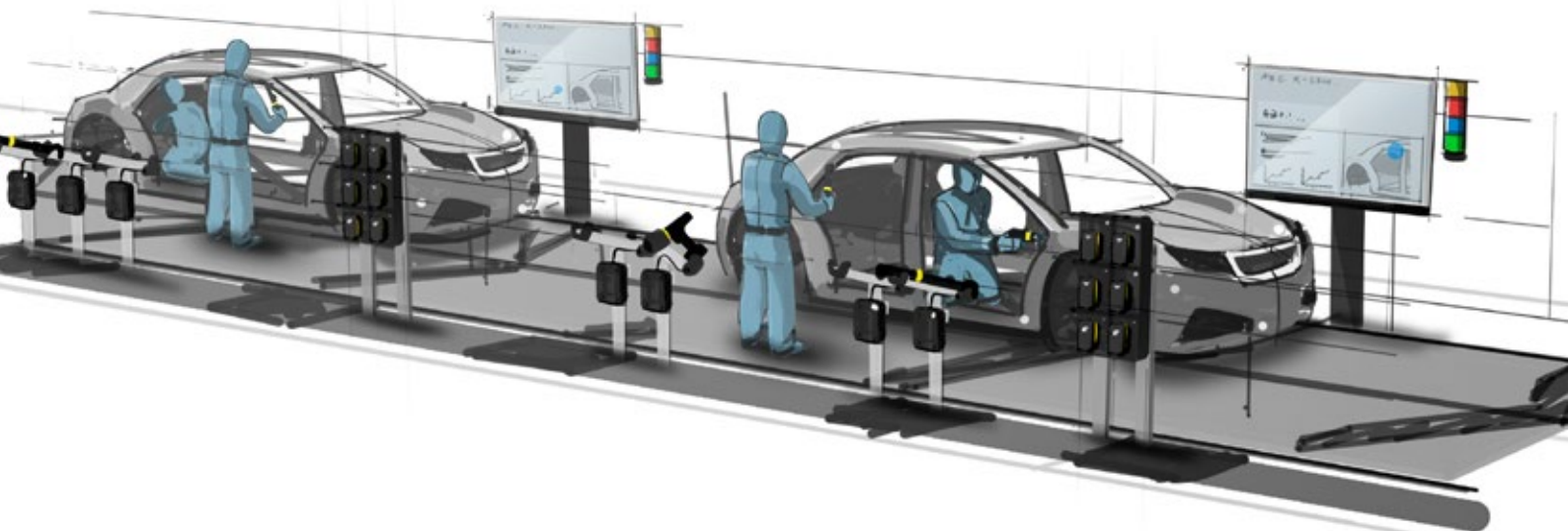

## 1.6 Digital manufacturing is already here

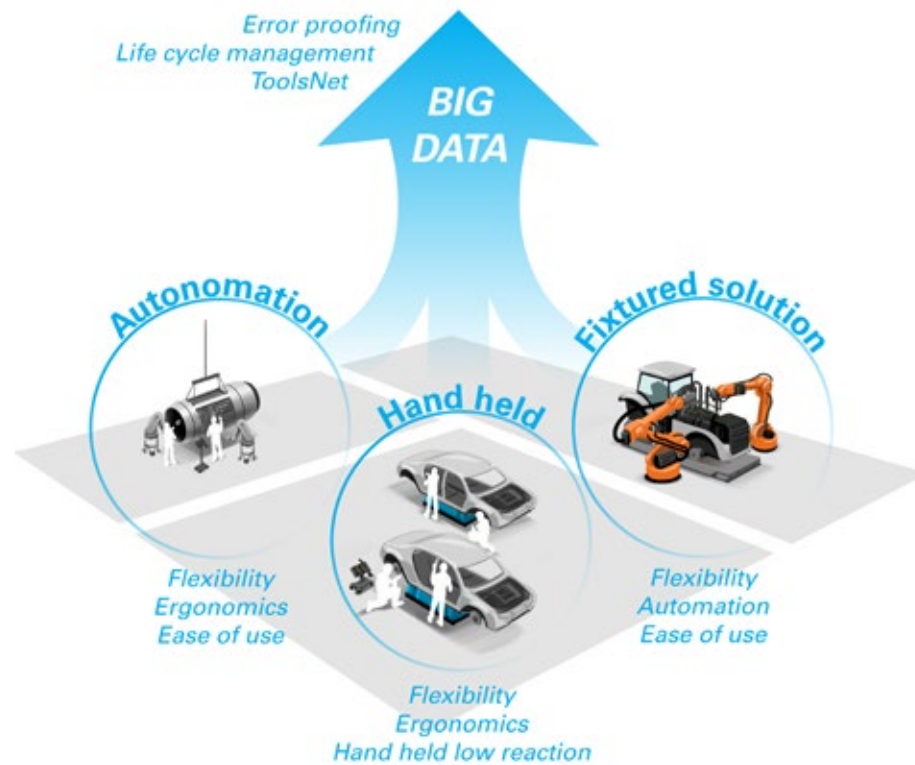

The first step that is happening now is the transfer of existing services and products to Industry 4.0 compliant standards. For many machines and products this means that the software and hardware architecture are modularized, interfaces are opened up to allow integration with third party systems, and that communication is built on standard technologies and protocols.

Our foreseen development includes four areas

- The technology is here and is rapidly being industrialized (explosion of sensors, low cost electronics, augmented reality, communication infrastructure)
- Open standards are emerging slowly and existing industry standards will initially exist in parallel
- The manufacturing software landscape needs to change to support the vision of Industry 4.0. The future is being shaped now and large investments from software-, infrastructure- and equipment providers are made in Industry 4.0 compliant systems
- Big Data and Analytics capabilities are growing fast

The development of technology has reached a stage where we either have internet enabled components on the market or

existing prototypes of technology that will be commercially available in the near future. There has been an explosion of sensors that can measure different physical quantities and distribute data in real time. Any process can be equipped with actuators and sensors to control and monitor each step of the process at a very detailed level.

In addition, low cost electronics for one-time use is becoming more and more affordable and the cost can therefore be carried by the end product. Printed electronics will open for materials and packaging to communicate with machines and systems controlling the assembly, manufacturing and supply chain process.

Standards are often proven to be highly cost efficient for all involved parties. However, in fast moving areas there is a balance between standardization and pace of development. When the future application can't be foreseen, an early standard can be hindering the development and not give the expected benefits. A number of infrastructure solutions for communication are emerging based on technologies and standards like wifi, 5G and Bluetooth. The design of modern equipment allows applications to use these technologies interchangeably.

Software communication protocols today are a mix of existing industry standards and

standards sanctioned by a standardization institute. These standards have typically been industry specific as the application and requirements on protocols vary by industry. Adaptors to convert between open standards and in-house formats, or different open standards, is a common solution that will likely be a part of the near term future architecture.

The software landscape of a manufacturer is potentially the area that is going to change the most. The increasing use of software in mechanical equipment, where functions previously realized with mechanical or electro mechanical solutions, are being replaced by a piece of software that creates new ways to define and control processes.

The IT systems of a manufacturing site have traditionally been based on a hierarchical structure for control and decision making, with clear set of logic at each hierarchical level. In a future landscape with smart tools and smart devices we expect to see systems with distributed intelligence where the control and decision making may be located anywhere in an eco-system.

The future architecture will be distributed and networked, and we see that many players are investing significant amounts of time and money to take a leading position in this emerging area. Traditional ERP vendors are investing to build capabilities in the MES (Manufacturing Execution Systems) area, niche players and MES vendors are adopting their

solution to align with a distributed architecture, industrial machine suppliers are expanding into the software business, and communication hardware suppliers are exploring opportunities to host logic in the communication network, just to mention a few examples. The latter is also called edge computing and aims to meet the needs of real time processing in a networked system.

Big Data and Analytics capabilities are growing fast and the cost of storage and analysis capacity has decreased to a level where the cost is not an issue to most companies. Many cloud based solutions to capture, store and make data available for analysis, are available, either as private cloud or by utilizing commercial clouds. The analytics capability is based on statistical methods and algorithms to identify information in big data that can be turned into intelligence. However, drawing the intelligence from big data requires deep domain expertise. Domain experts are required to design the algorithms that will turn data into adequate information and enable intelligence to be drawn from the information.

We expect this development to be an evolution building on existing assets and preferably adding systems rather than replacing systems in the near future. Even when establishing a greenfield plant, many existing IT assets are reused to avoid risks, obtain cost effectiveness, and benefit from corporate investments and standards.

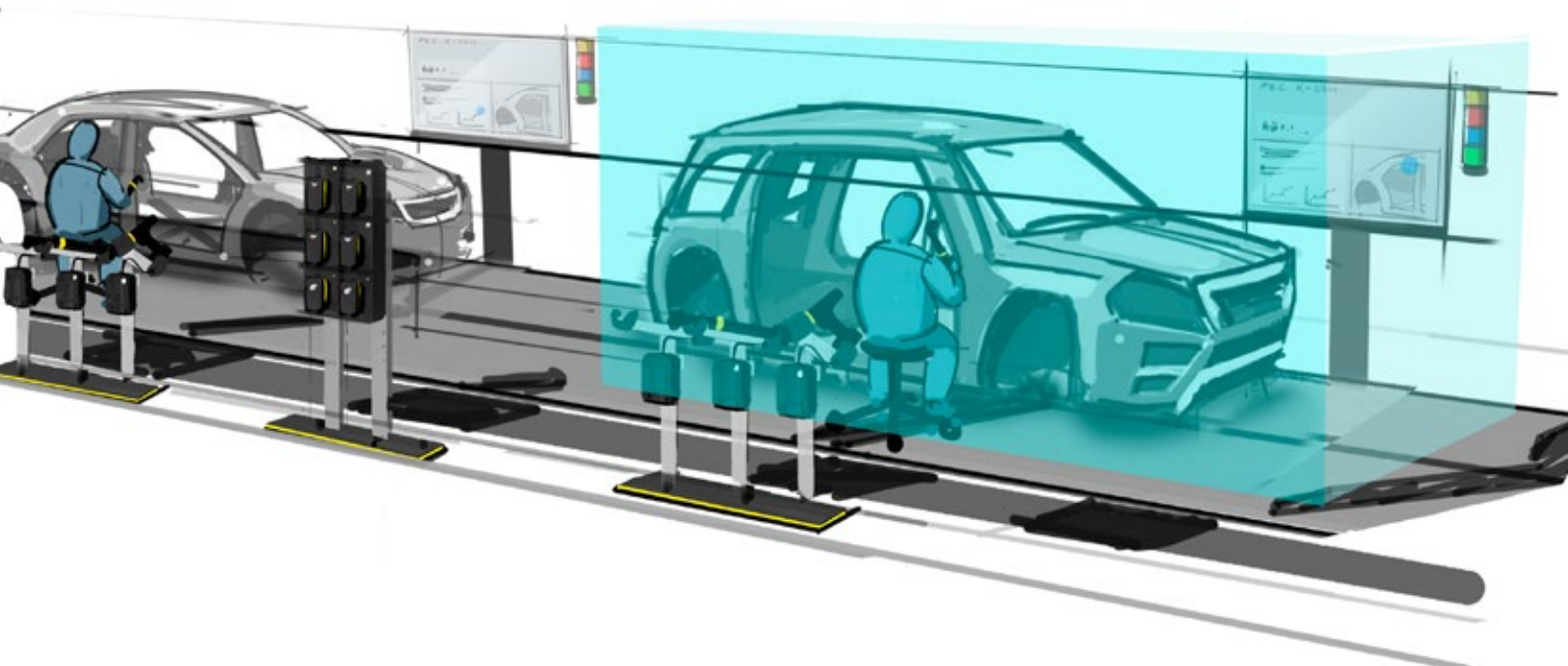

## 1.7 High performance assembly in the near future

The assembly process is also expected to be further digitalized, even though we assume that the process needs to be performed by a combination of humans and robots. Humans have the advantage that they can perform many operations in a small area where an automated line may require several stations with multiple robots each. Probably collaborative robots or humanoids, i.e. “human-like” robots will be the future. The collaborative robots can operate the assembly tools working shoulder by shoulder with human operators and for example perform ergonomically unhealthy operations.

The assembly of the future can benefit from the new technology in many areas including quality, process performance and overall cost efficiency. We have identified five key areas

- The assembly process
- Maintenance service shifts to guarantee tools availability
- Future new services based on big data analytics
- Support to R&D and simulation of assembly processes
- Automation of supporting processes like operator guidance and quality assurance

The future **assembly process** will have an improved performance and especially improved outcome of the process. The process

will include safety and operator guidance systems such as 3D positioning, pick-to-light, augmented reality solutions, and operator guidance displays that minimize human error and ensures that the right operations are performed.

The outcome of the process – the quality of the assembly – can then be guaranteed within a narrow tolerance range using additional sensors in the tools. Tools are equipped with sensors for speed, torque, acceleration, temperature, energy consumption etc.

In addition, critical applications will use material with built in sensors that communicate with the tool and enables assembly with very well defined fastening torque (clamping force). For example, the expansion of a bolt can be measured to give an accurate approximation of the fastening torque.

Improved ergonomics for operators is achieved by adopting the assembly process to the physics of an operator. In tightening, the speed and profiles are set to balance counter forces with the strength and working style of individuals. The ergonomics for operators also include operator interfaces that are intuitive and self-instructing. Installation and configuration of new operations are performed by any operator using semi-automatic and guided processes.

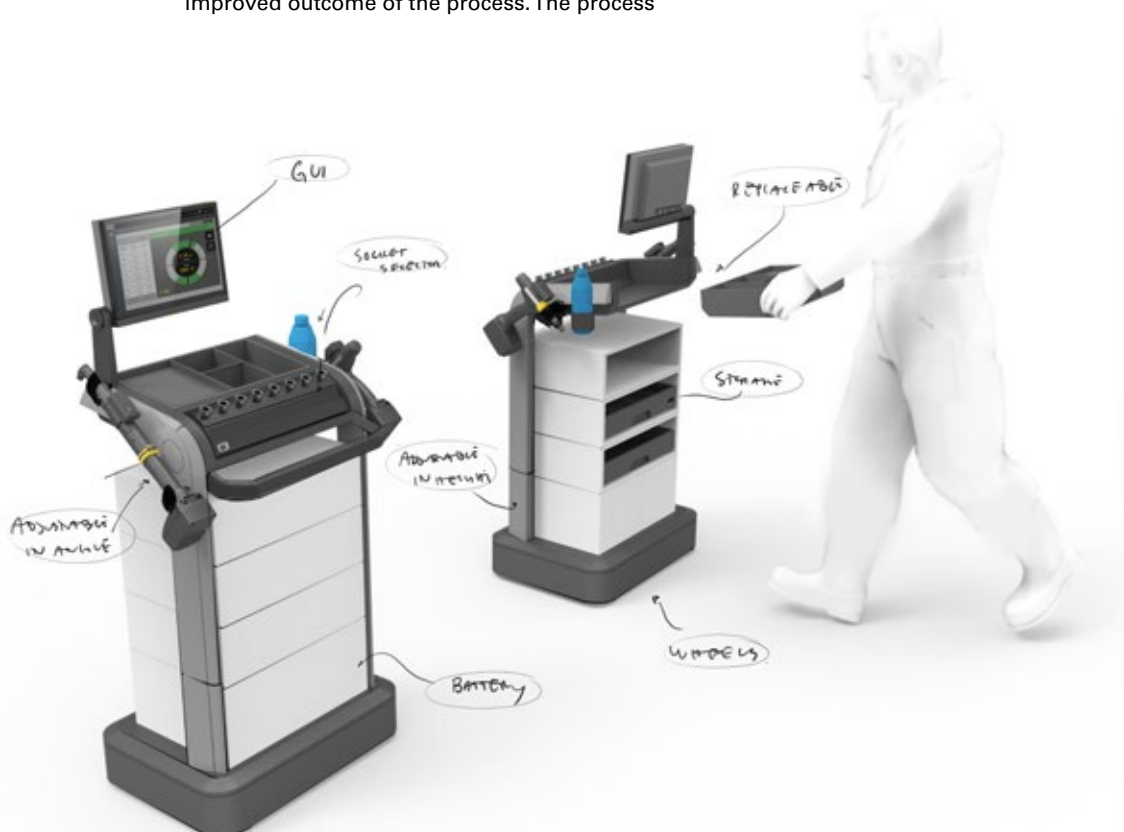

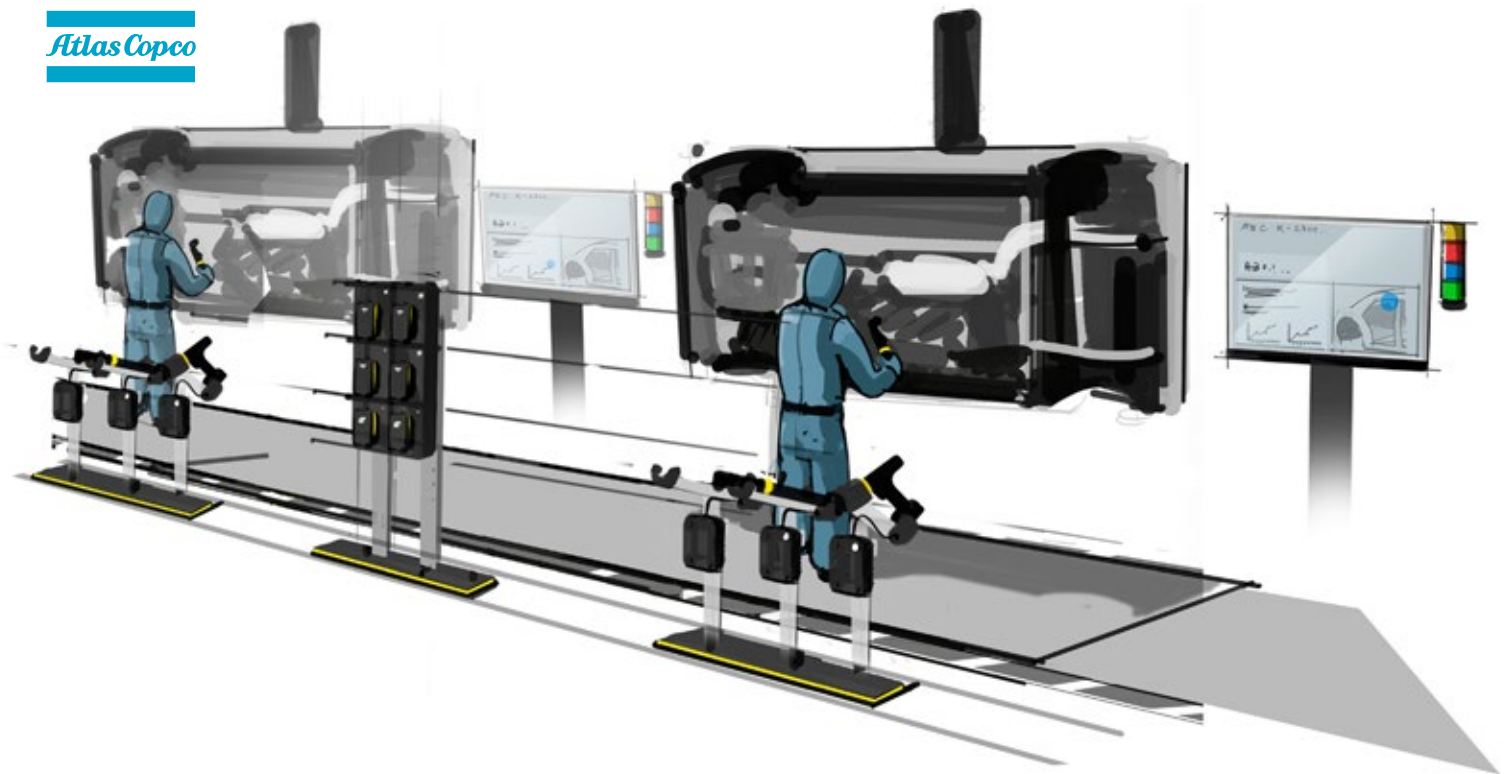

In the future we also expect adaptive processes sensitive to input material and individual operators. Imagine the material not being quality controlled by taking samples of a batch, but rather controlling each piece of material through an in-process inspection. The information of each inspection is shared with the tool when the material is fastened.

The second area is the **maintenance** of all tools and equipment at a plant. For many years it has been a well-known fact that preventive maintenance is preferred to unplanned repair. The issue has been to determine how much to invest in preventive maintenance, as the cost replaces the cost of breakdowns and unplanned repairs. The increased use of sensors and big data analytics enables whole new ways to statistically determine the need for maintenance. With predictive maintenance, multiple sources and parameters are used to model the likelihood for a failure.

Parameters that can give an early indication that something is starting to deviate from normal are for example; identification of deviations in energy consumption and trend analysis of performance data

The accuracy of prediction can be improved by sharing results and data across all tools at multiple sites and with multiple customers. This gives equipment manufacturers and maintenance service providers an advantage assuming they are granted access to all data.

Future equipment will know when it needs service and can communicate its state to maintenance applications. The technical development and increasing software component will enable remote services of equipment for both mass upgrades of software and specialists' investigation and guidance.

The increasing specialization of maintenance may change the way companies source service and increase the value add provided by external parties, and change the commercial set-up accordingly. Maintenance service in some industry sectors will shift from a fixed price or time and material business, to guarantee outcome or guarantee availability of equipment provided by service centers responsible for all equipment.

**Big data analytics** is highly relevant in an industrial environment where cost of downtime is high, and where small efficiency gains have an impact on productivity. The quality of the products produced is potentially the biggest opportunity as rework and recalls incur high costs in addition to the damaged reputation in the market.

Big data will be collected from an operation where multiple sensors and actuators generate information. All operations of a station are added and will provide information on the process and eventually the production line. Information from different production lines will be gathered within one site and across multiple sites of a company. From a technical perspective it is also possible to share information across multiple companies that are using similar equipment or performs the same type of operation.

Based on big data analytics we expect future new services to optimize the entire end to end production and logistic process. Bottlenecks can be identified and process flows synchronized. Comparison with best practice and knowledge transfer from other lines will be simplified all in favor of improved overall factory performance. With the new information utilization of assets can be monitored and the use of assets optimized.



Industries like Pharmaceutical and Automotive are regulated and the production process needs to meet good manufacturing practice. It also requires detailed data on the production process to be captured and stored for future records. Historically these requirements on traceability and audit trails have been implemented in stand-alone niche systems. The increasing possibilities of capturing data will likely result in an increasing demand from regulatory bodies as well.

A fast growing field is applications to support R&D and pilot builds with simulation of new designs and production processes. This enables a much faster development cycle and provide engineers with a rapid response of the feasibility to industrialize an idea. An assembly process can be modeled based on data from historical operations and competence of the

assembly process, including capabilities of available equipment and tools. We see a high demand for this type of services that are based on data and domain expertise and facilitates a close cooperation between R&D, production, and equipment providers.

In a longer perspective we anticipate an increased automation through the introduction of humanoids, human-like robots that can work together with the ordinary staff. Imagine a humanoid operating the assembly tools and making it possible to automate highly flexible processes and the humanoid following a processes controlled via advanced operator guidance systems such as visual projections directly on the piece on the operator workplace.



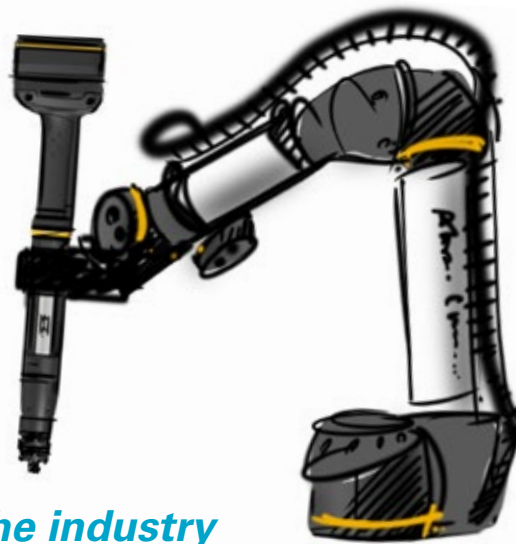

## 2. Benefits to the industry

### 2.1. The real economic value of Industry 4.0 is immense

As an example, Harvard Business Review (October 2015) is stating that we will see a whole new era of “lean” as smart, connected products will help make people, materials, energy, and plant and equipment far more productive. Data flowing to and from products will allow product use and activities across the value chain to be streamlined in countless new ways.

In addition, waste will be cut or eliminated. Sensors in products can identify the need for service before a component fails, or they

can reveal that maintenance isn’t necessary yet. Improved big data analytics capacity and capability will enable new types of services for efficiency improvements.

Inspired by a “lean manufacturing” perspective with a systematic approach for elimination of waste, the benefits of Industry 4.0 can be summarized by “the six pillars of value”; a framework created by Atlas Copco to illustrate and exemplify the potential value, all based on real customer cases.



**INCREASE UPTIME** by 78%  
- Tool up-time increase from 98% to 99,5% with preventive maintenance

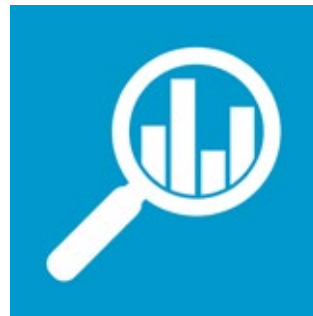

**REDUCTION IN DEFECTS** by 15%  
- Part verification with pick-to-light solution



**NEW PRODUCT INTRODUCTION COST** down 57%  
- From 3 500€ to 1 500€ using Virtual Stations

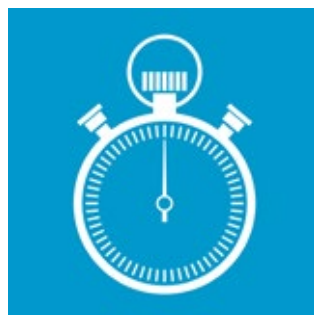

**IMPROVED PRODUCTIVITY** by 73%  
- First time through increased from 92,5% to 98% in one year with structured data analysis process



**HUMAN FACTORS** - 30%  
Reduction in training for new models or process changes with Operator Guidance



**REDUCTION IN ENERGY USE** by 80%  
- Multiple wireless tool running on one assembly process controller



The increase of **tool up-time** is achieved by combining a traditional approach for preventive maintenance, with a more data driven approach for predictive maintenance. One where maintenance tasks are determined by the condition of equipment instead of average or expected life statistics. With dramatically improved data analytics capability and sophisticated maintenance models, the repair can be scheduled at a time that minimizes the impact on production.



**Reduction in defects** and rework is enabled by integrating applications for part verification and documentation, operator guidance and pick-to-light solutions. The operator guidance application visualizes all process steps and data (e.g. camera images) to direct the operator through the assembly process and the pick-to-light system ensure the selection of the correct parts in the right quantities for versatile production processes.



**Introducing new products** often requires adding or moving production equipment around. By decentralizing control logic and virtualizing control logic, processes and operations can be added or moved without re-allocating or commissioning of new hardware. A simple software configuration change is all it takes. This simplifies the process and reduce cost for installing wiring, cabinets and boxes on the assembly line. The same benefits apply when re-balancing and assembly line to remove bottle necks and increase productivity.



**Improved productivity** is achieved through fewer reworkings, higher end-product quality and maximum uptime on the assembly line. These are just some of the many benefits offered by smart process monitoring and analysis software (e.g Atlas Copco ToolsNet) It enhances the capability to monitor, document, analyse, and continuously improve the assembly process on the assembly line to significantly reduce the number of "not OK" assemblies. By systematically checking the most frequent "not OK" applications on regular intervals and by analysing the trace information, speed, windows, the problems can be identified and rectified.



Smart integrated software solutions for enhanced operator guidance means fast recognition of rework process, traceability in assembly and manual operations, error proofing, data analysis, and plant monitoring. Resulting in a **reduced amount of operator training** required when introducing a new model and/or changing the assembly process.



Significant **reduction in energy use** is possible by virtualizing control logic and having one physical machine controlling multiple processes the potential for saving is significant. In a typical industrial environment, much of the energy is consumed by production equipment in stand-by. Recent studies indicate that up to 80% of this energy is consumed when the equipment and tools are in stand-by mode. For factories powered by wind and solar reducing energy consumption is more than a cost reduction, it's a necessity to meet environmental policies.

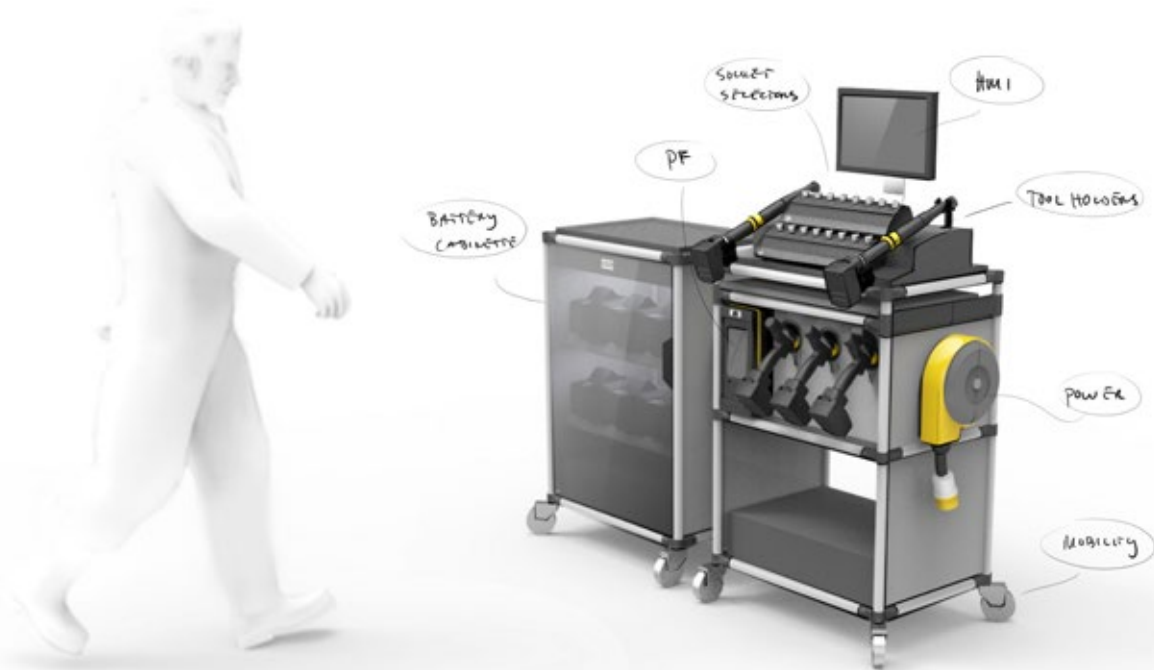

**The solution includes:**

*High performance wireless tools*

- PF6000 controller & Tensor STB wireless tools
- Multiple programs and high torque accuracy
- Angle and torque monitoring
- Recording and traceability of all assembly data

*Identification and real time location*

- RFID and bar code identification of work pieces, components, tools, product specific workbenches etc
- Operator guidance
- Displays to guide operator in each step through an assembly process specified in detailed
- Electronic pointer (projector) systems to project information on the work piece
- Pick to light system to ensure selection of correct parts
- Synatec integration software

*Closed loop quality assurance*

- Systematic quality assurance and proofing
- Process spanning R&D, Production
- Service STa6000 and STwrench with QS-loop process optimization software

**2.2. Case Description– Error proofing in advanced machine building**

A leading industrial engineering company in The Netherlands design and sell advanced machines to manufacturers globally. The machines are highly sophisticated using multiple technologies to support production with very high precision and speed. A machine takes weeks to build and in the final assembly stage alone, more than thousands of bolts and screws are mounted.

Superior quality in all parts of the machines, is of essence to meet the performance requirements. This also includes tightenings as one bolt that loosens or comes off can have a devastating effect and cause stop of production for weeks while being repaired.

Three years ago the company turned to Atlas Copco to further improve the quality of its assembly processes. Atlas Copco and the company worked together to evaluate and design a high performance assembly solution. The team came up with a solution based on high performance tools and multiple error proofing systems.

The solution is a network of intelligent systems, specialized in different areas, that communicate with each other to manage the assembly process. The product assembled at a station is identified via RFID on the work piece. Once the work piece is identified the working procedures, material needs, and tool requirements are known by the system. The operator guidance system is the heart of the solution and interacts with the other systems to guide, control and verify the assembly operations. A sub-system will receive a signal to initiate an operation and each sub-system will include all the logic needed to perform

its operations and report the outcome. For example, to tighten a bolt, or to ensure that the right piece is picked.

A systematic feedback loop has also been introduced where R&D, Production and Service share test results and monitor quality performance. For example, service can measure residual torque of critical fasteners after 6 months or one year. If the result is outside limits, R&D investigates a solution together with production, and the assembly program can be modified.

The most important benefit is that the number of defect assemblies have reduced to almost zero in shipped machines and issues detected at internal tests have reduced significantly. This is a result of an assembly process performed according to a detailed specification, with support systems to ensure correct fasteners at the right location tightened with a highly accurate torque.

The continuous improvement work has also been taken to the next level with the new feedback loop cross Service-Production-R&D, and the extensive collection of data. Assembly results and tool execution data are brought together with data from quality inspections, service activities and customer incidents with full traceability at single bolt level.

In addition, the control systems are easy to configure and modify when production changes. It is a distributed system so changes can be made for one station and then distributed to all stations.

Atlas Copco has a long history of connected tools performing real time controlling and collecting data from the assembly process. It has an analysis application that can optimize the programming of a tool for an ideal assembly as well as applications for traceability and tracking.

### 3. Atlas Copco portfolio of systems and services

Atlas Copco has many customers in the forefront of manufacturing in Automotive, Aerospace, Electronics, Home Appliances and Industrial Assembly. These sectors often lead the development with many others sectors following them closely. The general objectives of cost efficiency, increased flexibility, and improved quality are highly relevant to these customers and their assembly operations.

Atlas Copco are experts in the assembly process and focus on fastening technologies with bolted joint as the main technology, and gluing and riveting as growing technologies for lightweight materials. Atlas Copco delivers stand-alone solutions and solutions integrated with the manufacturers ERP and manufacturing systems. The tools are operated by humans or mounted on robots. In this section we outline the most advanced solutions operated by humans.

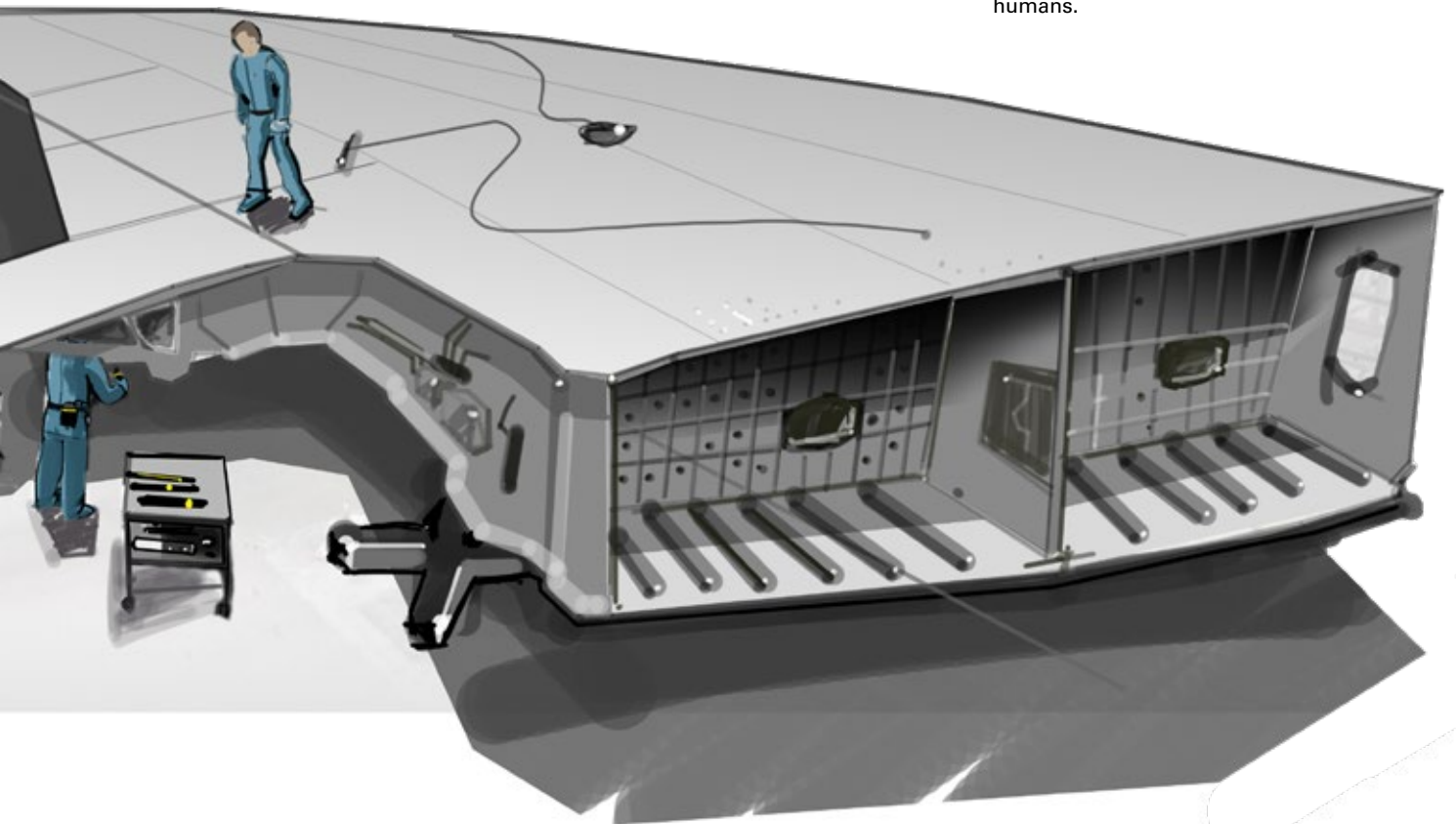

### 3.1 Atlas Copco outlook

Atlas Copco work closely with customers to develop customer tailored solutions and are often part of different expansion or upgrade projects. In addition, the service operation provides valuable insights on how the

products and systems are functioning years after installation. This, together with Atlas Copco's own research, gives input on future requirements and enabling technologies.

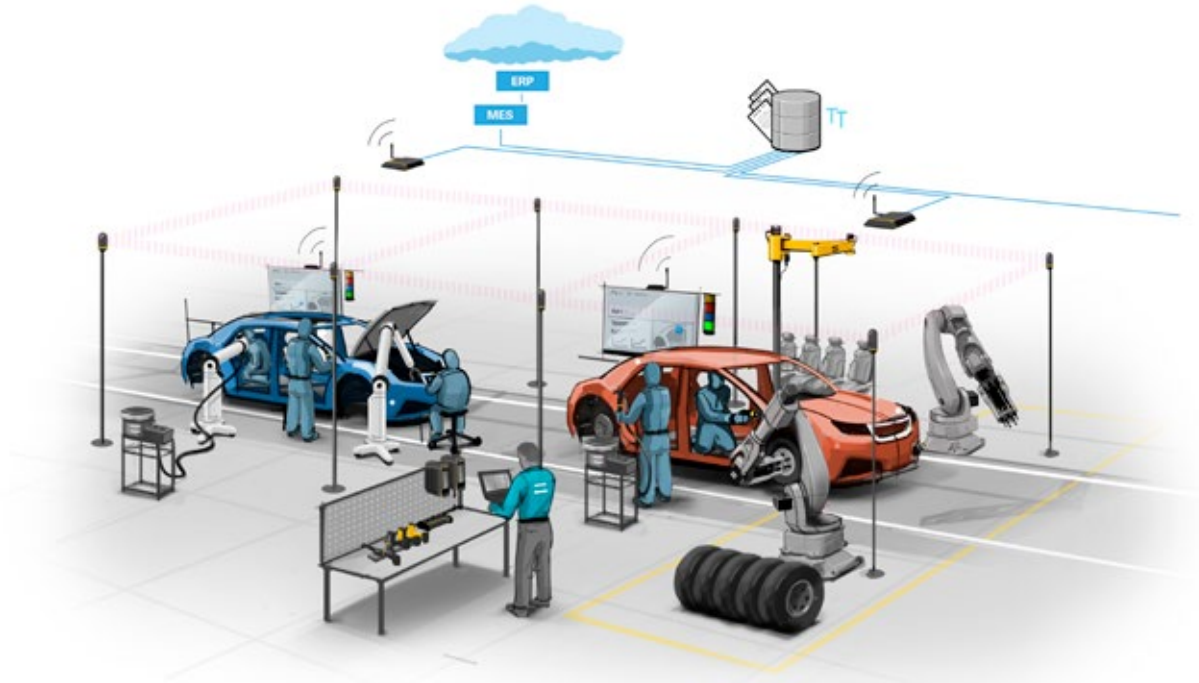

The performance and outcome of an assembly process is vital to the quality of the end product in many advanced industries. Atlas Copco envisions solutions in the near future that will provide

- Guaranteed outcome of the assembly process
  - Adaptive processes to input material and individual operators to increase safety and quality
- Guaranteed availability of the tools or guaranteed outcome of a station
- Horizontal integration between R&D, Production and Service to close the feedback and support loop
- New services based on real time data and data analytics
  - Asset optimization and improved factory performance
  - Predictive maintenance
- Ergonomic and easy to use machine interfaces
  - Intuitive and self-instructive “app like” software applications
  - Automatic distribution of configurations and settings to tools in the system

- Industry 4.0 compliant architecture supporting
  - Modular design with applications running in a distributed environment including real time nodes and Cloud based virtual servers
  - Standard communication infrastructure
  - Remotely controlled software and automatic upgrades

Atlas Copco are developing the assembly process with a focus on safety and ergonomics with an aim to reach zero defects. Improved consistency within small tolerances will be achieved through elimination of human errors and further improved tool performance.

Safety systems to guide and control an operator are increasingly important to help minimize human errors. Atlas Copco supports multiple technologies like 3D positioning, Operator guidance, pick to light, and systems to project information on the work piece. The assembly process controller and all these systems communicate and form an intelligent networked solution to ensure that the assembly process is carried out correctly.

Tool ergonomics and performance is improved as an evolution of existing processes based on angle, torque and speed, with an addition of new sensors for acceleration and vibrations.



These sensors enable more ergonomic assembly, making it possible to automatically adopt the process to the strength and handling style of each individual worker. This ensures an end result that is consistent irrespectively of the human factor. In addition, the additional sensors will improve the capabilities to detect any malfunctioning of a tool.

For highly critical applications such as the airline industry, we expect tools and materials to communicate and dynamically determine the optimal assembly process. For instance, the ideal measure of a tightening would be to measure the clamping force between the two materials. As this is hardly feasible, a second best option is to measure the expansion of the joint bolt. Imagine bolts with a built in tension sensor communicating tension data in real time to the tightening tool.

One of the main benefits with connected tools comes from the possibilities to draw intelligence based on big data analytics and statistical modeling. Atlas Copco develops enterprise solutions for management and maintenance of assembly tools. The predictive maintenance solution is based on Atlas Copco's deep knowledge of fastening processes and statistical analysis of patterns and trends found in big data. The solution will grow learnings from a tool, a station, a line, a factory, to a network of factories and will enable completely new insights from data.

The solution currently available, supports functionality

- to guarantee availability of tools based on a high degree of intelligence
- to identify early warnings and deviations in tool performance
- to remotely monitor and control a tool or a group of tools
- to enable back-tracing of quality of the last products produced just before a breakdown of a tool

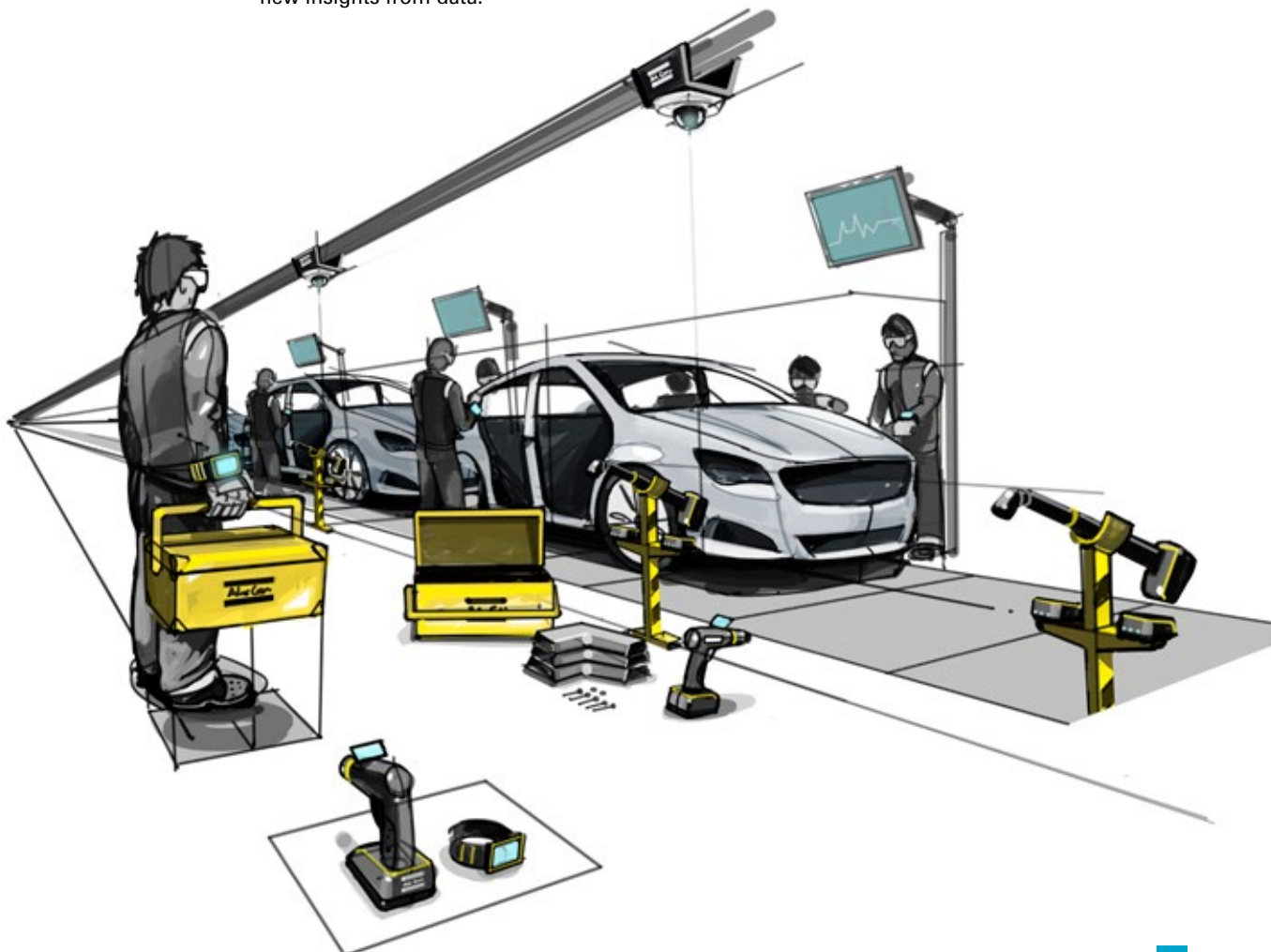

### 3.2. Atlas Copco solution

Atlas Copco are specialists in assembly processes for metals and lightweight materials. They provides high performance tools and services to a number of focused industries where performance and outcome of the assembly process are essential. Besides the physical equipment, Atlas Copco offer real time control, process support and operator

guidance. And in addition to the assembly process Atlas Copco offers extensive support and applications for maintenance and process performance analytics. The various services are based on Tools Net and the Smart Service platform, which is an open platform connection for tools and devices from Atlas Copco and third parties.

#### Smart connected tools

**The core in any solution from Atlas Copco Industrial Technique are the tools.** The tools range from high precision low torque tools, to tools for high speed assembly. From fastenings with large clamping force in the construction industry, to the challenges in the white goods industry. The tools for lightweight material include gluing and riveting tools. All tools, whether electrical or pneumatic, and independently of fastening technology, are made in multiple designs to meet different ergonomic needs.

#### The intelligence of the smart connected tools are built from three capabilities

- a real time controller in the tool
- multiple sensors to measure the process
- wired or wireless connectivity

**The real time controller monitors and controls the tool operation with 8 kHz** and is programmed to deliver an optimal and ergonomic process profile. In addition, it ensures safety through communication with various safety systems.

**Different sensors have for a long time been essential to control** the high performance tools and to guarantee consistent quality and performance. Atlas Copco's advanced tools are equipped with sensors for angle, torque, speed, acceleration, vibrations, temperature, and energy consumption.

**Multiple protocols and communication technologies** like Bluetooth, wifi, and 5G are supported to enable utilization of a plants communication infrastructure.

#### Smart assembly systems

**When smart connected tools are used to support** an assembly line together with other connected systems, real benefits can be achieved. This is where Quality Assurance and Service are integrated with production in a loop to feedback information. Atlas Copco calls this concept Smart Connected Assembly.

**The smart connected assembly is a networked system with distributed logic and intelligence,** where the assembly process and tools requirement are controlled by the piece on the workbench and the outcome is reported to the production system. The assembly process is controlled by the Atlas Copco system which integrates the tools with operator guidance, pick to light, 3D positioning, visual projections on piece, or augmented reality solutions.

**Services to improve productivity and quality are taken to a new level** with the smart connected assembly concept. Atlas Copco offer solutions to optimize the assembly process based on detailed sensor data and big data analytics. This enables higher performance and quality of a fastening, and it also enables improved performance of the entire assembly process.

**The increased data on tool usage and tool performance** enables a more efficient maintenance of the tools. Atlas Copco's service concept includes tool management systems to monitor usage. To determine maintenance needs based on advanced statistical models and predictive maintenance. As a result, tool availability at the right location can always be guaranteed. The life cycle cost will also be reduced as maintenance is optimized.

**The smart connected assembly concept** facilitates feedback loops between Service, Production and Product Development. Problems detected by field service in regular quality inspections can be traced back to assembly and product design in order to identify its root cause.

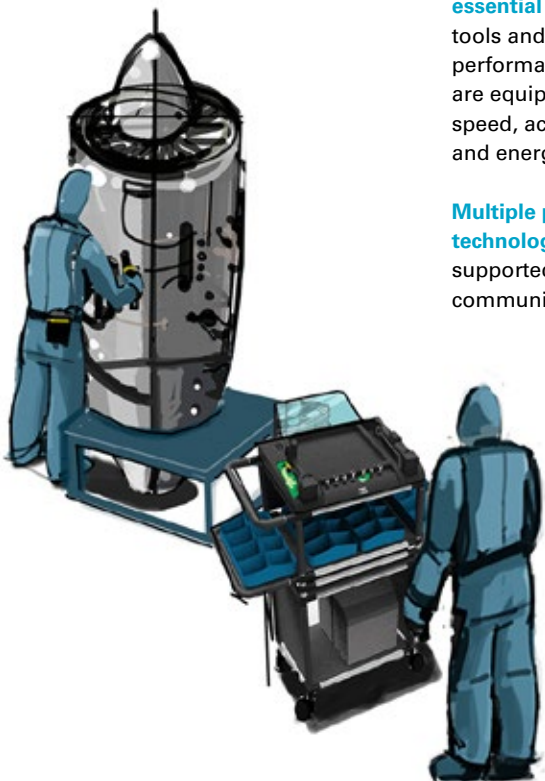



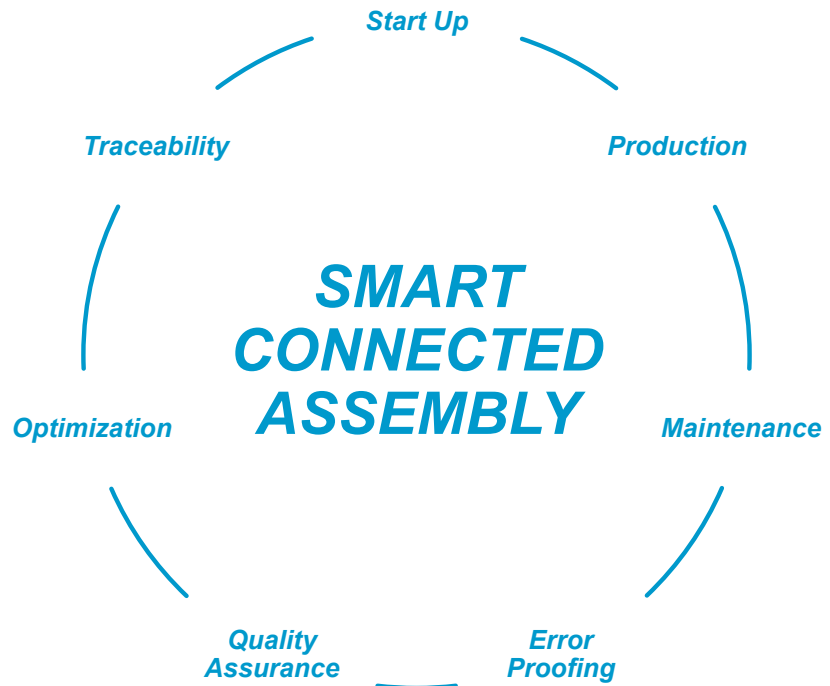

**Atlas Copco history of connected products**

2000 – Power Focus 3000, the first fully connected tool controller!

2003 – Tools Net 3000 storing production data. More than 1000 installations worldwide.

2008 – Tensor STB Cordless freedom.

More than 10 000 tools installed

2016 – Industry 4.0 ready

3.3. The technical architecture

The new generation of systems is designed for openness and collaboration in a network of distributed logic. This is different from older designs that typically had an architecture with clear hierarchical layers of logic and that were closed systems using proprietary interfaces that were complicated to integrate with other systems.

The Atlas Copco solution is designed based on the following principles and assumptions

- A factory will have a common communication infrastructure based on wifi, 5G, Bluetooth, etc
- Cyber Security is required at both infrastructure and application layer
- A factory will have a cloud solution (or data centre) for storage and data processing (non real time critical)
- Real time control needs to be performed locally, initially at local computers and possibly using edge computing in the future
- Services and applications like big data analytics are designed to run in the cloud
- Data on the assembly process is available to third party applications using open standards, such as Atlas Copco Open Protocol

The architecture allows easy integration with multiple architectures within the clients manufacturing systems landscape. The modularization of Atlas Copco's solution is compliant with the ISA 95 model and the Industry 4.0 model.

The architecture is designed to allow easy integration with multiple architectures of Atlas Copco's clients' manufacturing systems landscapes. The manufacturing IT landscape and strategies vary across industries and between different companies. The modularization of Atlas Copco's solution is compliant with the ISA 95 model and the Industry 4.0 model.

We see manufacturers investing in Industry 4.0 either as a greenfield plant or more commonly as an evolution and stepwise upgrade of an existing assembly line. Atlas Copco's modular design is well suited to support these scenarios and allows manufacturers to build on existing assets and add Industry 4.0 applications.

- The Atlas Copco products and services are developed for Industry 4.0 ready production and assembly
- The tools are equipped with sensors and can send data to the environment wirelessly
- A controller controls the process and safety of an assembly process
- All data and results from the assembly process are captured and stored in a database. In addition, tool performance data is captured and stored.

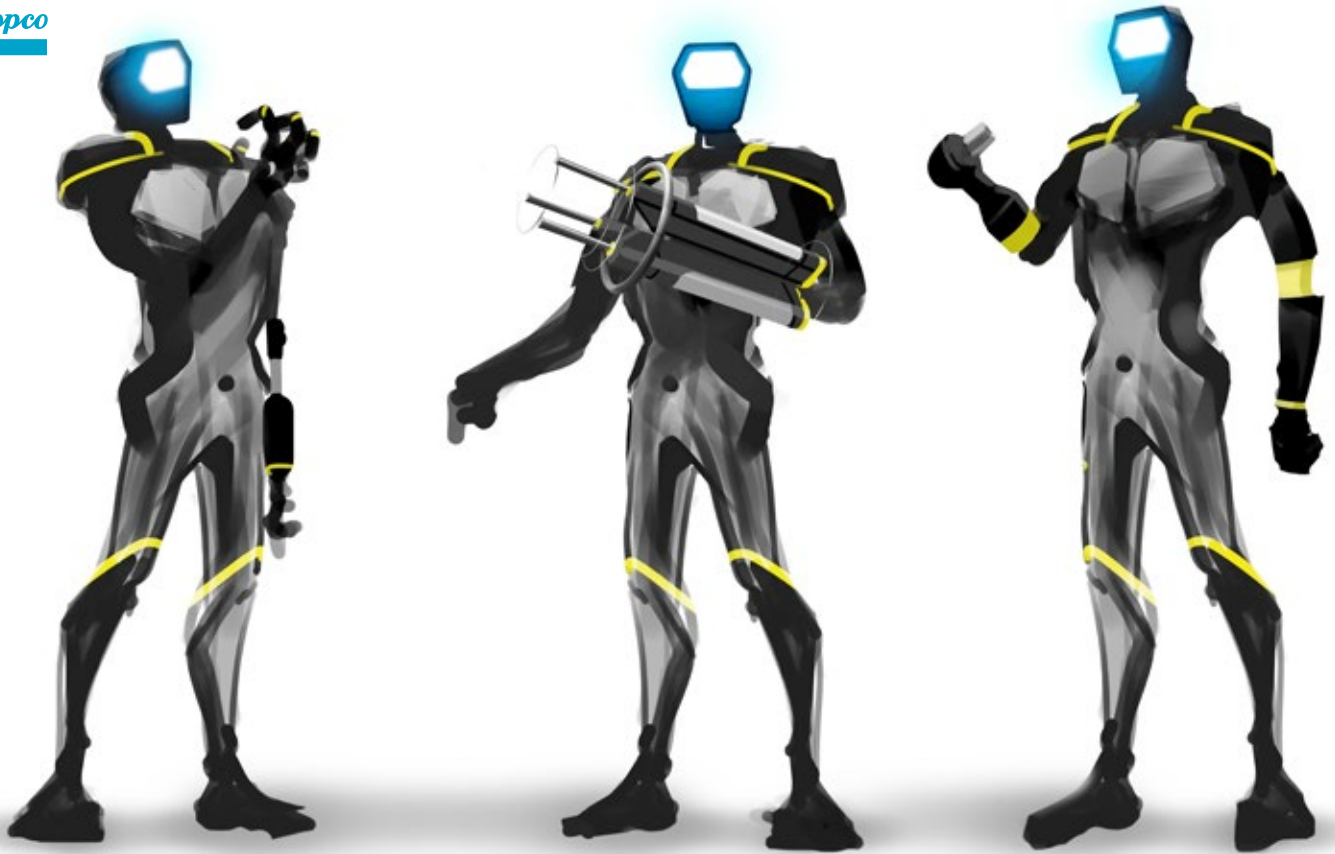

## 4. Shaping the future together

Atlas Copco are committed to continue to be the obvious choice to help customers raise productivity and cut operating costs. This through an innovative and reliable portfolio of fast, powerful, and accurate tools – and systems for tightening, adhesive and self-pierce riveting processes.

Atlas Copco Industrial technique is therefore increasing its efforts to explore how to deploy Industry 4.0 technologies offering the greatest benefits to its customer base across Motor Vehicle industry and General industry.

The strategic roadmap, designed around four action fields, is based on current Atlas Copco strengths; e.g. large installed ToolsNet base, existing portfolio of connected devices, focused investments in R&D, and a global service organization.

**Continued investments for digitalization of Atlas Copco systems and services** portfolio ensuring current and future products and services are Industry 4.0 compliant. Industry 4.0 product features need to be supporting open standards, meeting requirements on connectivity, real-time information, security and traceability.

**Develop and introduce new “data driven” services** (and business models) to strengthen value proposition to customers. One illustrative example is the gradual shift from traditional preventive maintenance to smart predictive maintenance, based on optimized condition

monitoring automatically triggering servicing and maintenance work where required. and maintenance work where required.

**Explore opportunities and potential for vertical collaboration to offer customers seamless services.** Smart, connected products require customers to build and support an entirely new technology infrastructure. From product sensors and embedded software, to manufacturing execution systems – and integration with enterprise business systems including a new suite of data security systems. Atlas Copco will, be providing parts of this infrastructure but will also, together with its customers and other system providers, take an active role in promoting easy and secure connectivity and standardized formats for exchange of information.

**Initiate collaboration with ecosystem value partners.** Atlas Copco’s future product and service portfolio and value proposition to its customer base will be connected to, and dependent on, other partners in the value chain. It is therefore a strategic imperative for Atlas Copco to be a driving force to overcome common industry challenges around security, compliance and standardization. With a long history and strong reputation of offering customers genuine process and application know-how, Atlas Copco will actively be engaging with other ecosystem value partners to promote solutions that ultimately will offer customers integrated Industry 4.0 solutions. ■

## Finishing summary

Atlas Copco are in the forefront, leading the change towards true digital manufacturing and smart connected assembly. Atlas Copco will, together with other eco-system partners, continue to help customers to navigate and speed up the challenging and exciting journey ahead. The vision of Industry 4.0 presents tremendous opportunities and Atlas Copco are working globally every day, side-by-side with its customers, to turn the vision into reality.



## *Committed to Sustainable Productivity*

We stand by our responsibilities towards our customers,  
towards the environment and the people around us.  
We make performance stand the test of time.  
This is what we call – Sustainable Productivity.

[www.atlascopco.com](http://www.atlascopco.com)

The Atlas Copco logo consists of the company name in a white, italicized serif font, centered between two horizontal white bars of equal length.

*Atlas Copco*